

PROFURL[®] MANUEL DE MONTAGE
CLASSIC / ELITE *INSTALLATION MANUAL*



TABLE DES MATIERES

CONTENTS

	Pages	
- Introduction	2	- <i>Introduction</i>
- Nomenclature et identification des modèles N- L- NC- LC	3-4	- <i>Identification of Models N- L- NC- LC</i>
- Nomenclature et identification des modèles C- R	5-6	- <i>Identification of Models C- R</i>
- Hauteur du tambour au-dessus du pont en fonction de la terminaison inférieure	7-8	- <i>Height of drum mechanism above the deck according to lower terminal</i>
- Séquences à suivre pour le montage du mécanisme inférieur	9	- <i>Sequences to be followed to fit the drum mechanism</i>
- Préparation	10	- <i>Preparation</i>
- Montage du mécanisme inférieur : Tous modèles	11-12	- <i>Fitting the drum mechanism: Alls Models</i>
- Modèles C- R	13	- <i>Models C- R</i>
. Avec avale-ridoir	13-14	. <i>With internal rigging screw cylinder</i>
. Avec avale-ridoir et lattes longues	13-14	. <i>With internal rigging screw cylinder and long link plates</i>
- Réglage du ridoir avec avale ridoir	15	- <i>Rigging screw adjustment</i>
- Mise à longueur des gaines	16-17	- <i>Cutting extrusions to length</i>
- Montage du Multitop	17	- <i>Fitting the Wrapstop</i>
- Montage des gaines	18	- <i>Extrusions assembly</i>
- Jonctions entre les gaines	19	- <i>Couplings between extrusions</i>
- Montage de l'émerillon	20	- <i>Fitting the halyard swivel</i>
- Montage du guide ralingue	20	- <i>Fitting the feeder</i>
- Fixation de la gaine inférieure sur le mécanisme inférieur	21	- <i>Securing the lower extrusion on the drum mechanism</i>
- Installation à bord	22	- <i>Fitting on board</i>
- Mise en place du cordage de manoeuvre	23	- <i>Fitting the reefing-furling line</i>
- Hisser la voile	24	- <i>Hoisting the sail</i>
- Réglage de l'émerillon	25	- <i>Halyard swivel adjustment</i>
- Montage sur un étai en rod	26	- <i>Fitting over a rod stay</i>
- Utilisation des modèles C- R en étai creux	27	- <i>Using C- R models as a racing foil</i>
- Spécifications concernant les voiles	28	- <i>Sails specifications</i>
- Conseils d'utilisation	28	- <i>Operation</i>
- Dimensions des enrouleurs	29-30	- <i>Sizes of Profurl units</i>
- Défauts de fonctionnement	31	- <i>Operation troubles</i>
- Entretien	31	- <i>Maintenance</i>
- Pièces détachées	32-37	- <i>Spare parts</i>

RECEPTION DU MATERIEL

Le matériel voyage toujours aux risques et périls du destinataire. Il y a donc lieu d'effectuer une vérification dès réception et émettre toutes les réserves ou exercer tous recours dans les délais réglementaires à l'encontre des transporteurs.

RECEIPT OF GOODS

All goods must be checked on delivery and the Buyer should claim from the carrier verbally within three days in the event of loss or damage, and in writing within seven days.

Cette notice de montage concerne l'ensemble de la gamme des enrouleurs de foc manuels PROFURL. Il vous suffit de suivre pour le montage uniquement les séquences qui concernent votre modèle d'enrouleur et le type d'installation souhaité.

This installation manual covers the whole range of PROFURL manual reefing-furling systems. To fit your system, just follow the sequences corresponding to your type of system and the installation desired.



Sur toutes les vues, le haut de l'étai est représenté sur le côté droit, et le bas du côté gauche.

On all sequences the top of the forestay is shown on the right side and the bottom on the left side.

MODELES NC 32
MODELS LC 32
 NC 42
 LC 42
 LC 42R
 N 52
 L 52

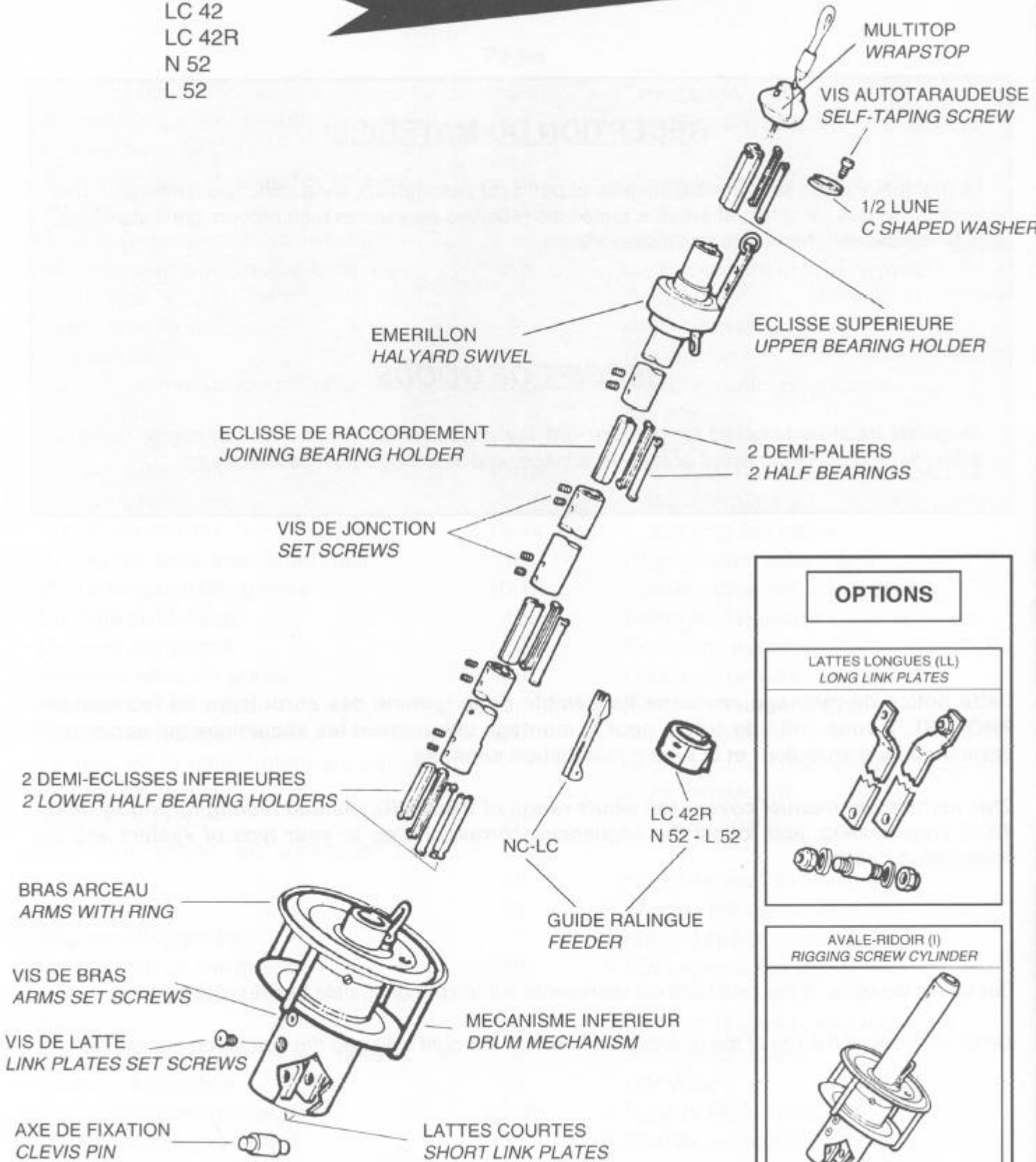
TABLE DES MATIERES

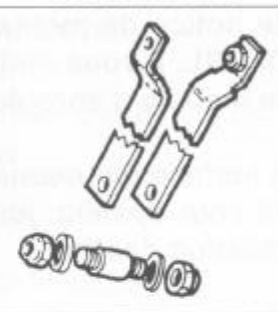

OPTIONS
LATTES LONGUES (LL) LONG LINK PLATES 
AVALE-RIDOIR (I) RIGGING SCREW CYLINDER 

**TAMBOUR NON DEMONTABLE
FIXED DRUM**



**GUIDE RALINGUE DES
FIXED FEEDER OF**

MODELES } LC 42R
MODELS } N 52 - L 52

MODELES } NC 32 - LC 32
MODELS } NC 42 - LC 42

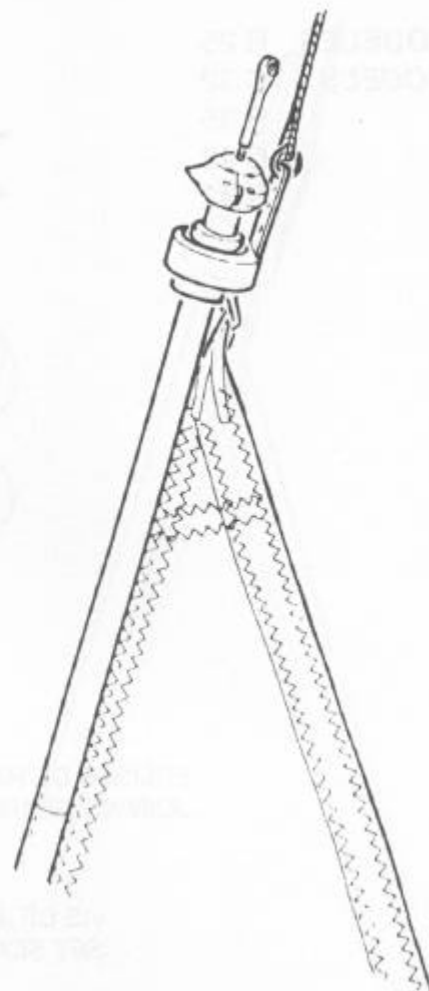
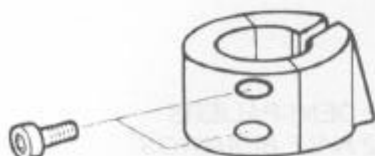

LES LATTES LONGUES PERMETTENT :

- de réaliser un montage sur ridoir, les lattes venant se placer de part et d'autre du corps du ridoir.
- de surélever le tambour par rapport au pont pour faciliter le passage de l'ancre et améliorer la visibilité sous le gènois.

THE LONG LINK PLATES ALLOWS :

- fitting over a rigging screw. These long link plates are installed on each side of the rigging screw body.
- to raise the drum above the deck, in order to make easier anchoring or to improve visibility under the genoa.

L'AVALE RIDOIR PERMET :

- En présence d'un ridoir de rabaisser le tambour pour une longueur de guindant maximale.

THE RIGGING SCREW CYLINDER ALLOWS :

- If there is a rigging screw to lower the drum for maximum sail luff length.

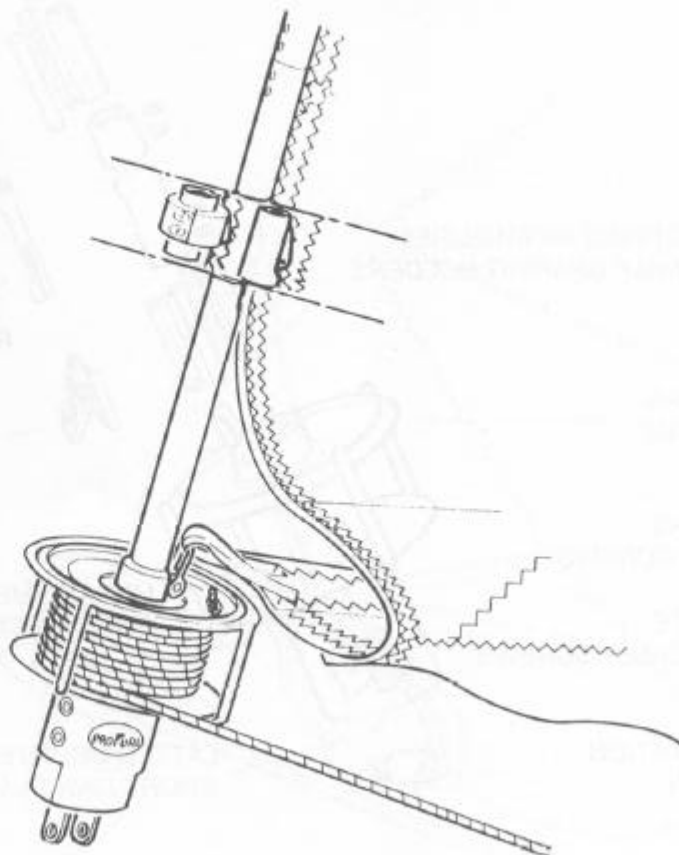

MODELES R 25
MODELS C 32
 R 35
 C 42
 R 42

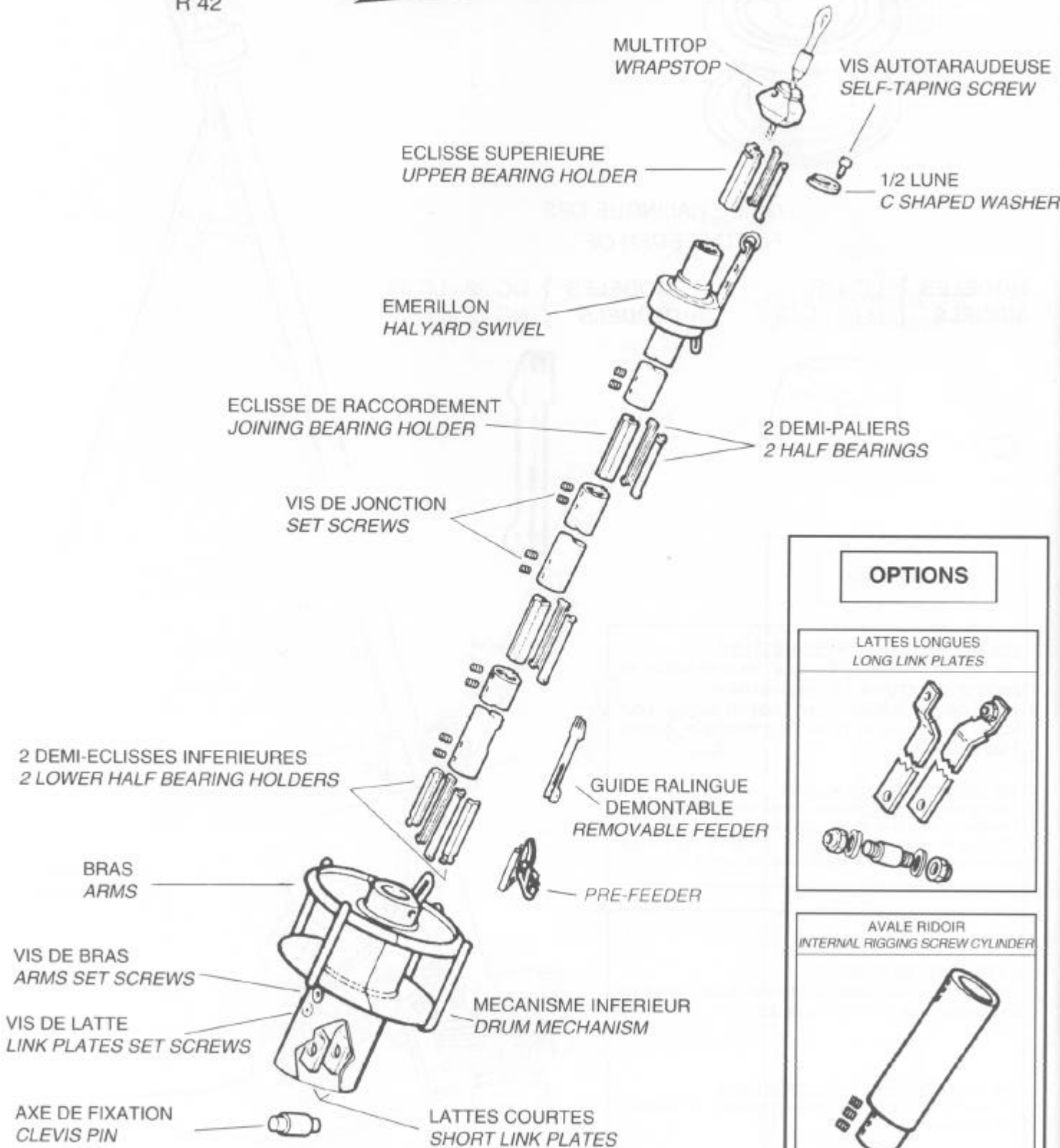

OPTIONS	
LATTES LONGUES LONG LINK PLATES	
AVALE RIDOIR INTERNAL RIGGING SCREW CYLINDER	

SONT IDENTIFIABLE PAR
ARE IDENTIFIED BY

TAMBOUR DEMONTABLE
SPLIT DRUM

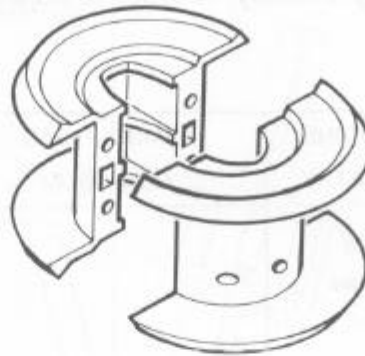

ET/AND

PRE-FEEDER

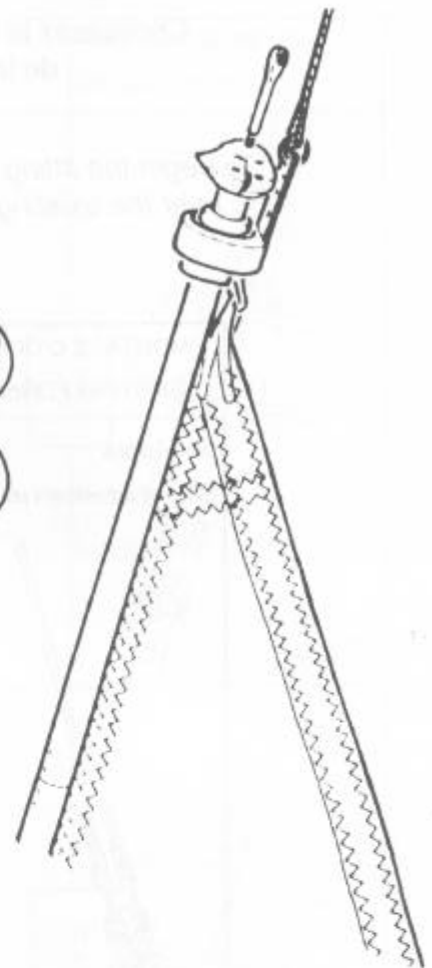

LES LATTES LONGUES PERMETTENT :

- de réaliser un montage sur ridoir, les lattes venant se placer de part et d'autre du corps du ridoir.
- de surélever le tambour par rapport au pont pour faciliter le passage de l'ancre et améliorer la visibilité sous le génois.

THE LONG LINK PLATES ALLOWS :

- fitting over a rigging screw. These long link plates are installed on each side of the rigging screw body.
- to raise the drum above the deck, in order to make easier anchoring or to improve visibility under the genoa.

L'AVALE RIDOIR PERMET :

- En présence d'un ridoir de rabaisser le tambour pour une longueur de guindant maximale.

THE RIGGING SCREW CYLINDER ALLOWS :

- If there is a rigging screw to lower the drum for maximum sail luff length.

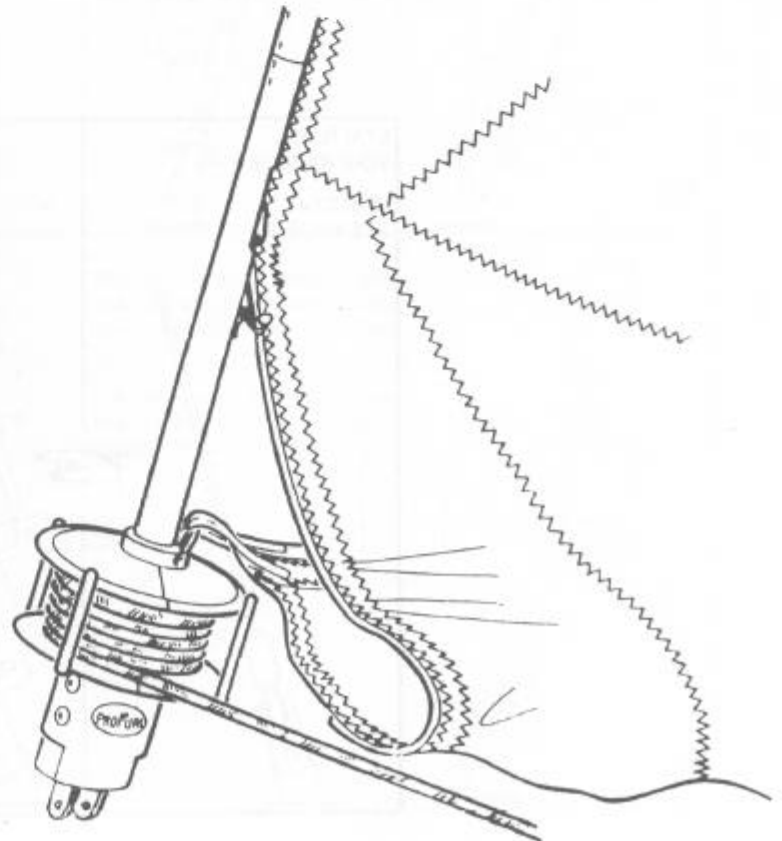

Choisissez la hauteur du tambour au dessus du pont en fonction de la terminaison inférieure de l'étau d'origine.

To begin the fitting you will have to install temporarily the drum mechanism over the existing forestay, in order to adjust its height above the deck.

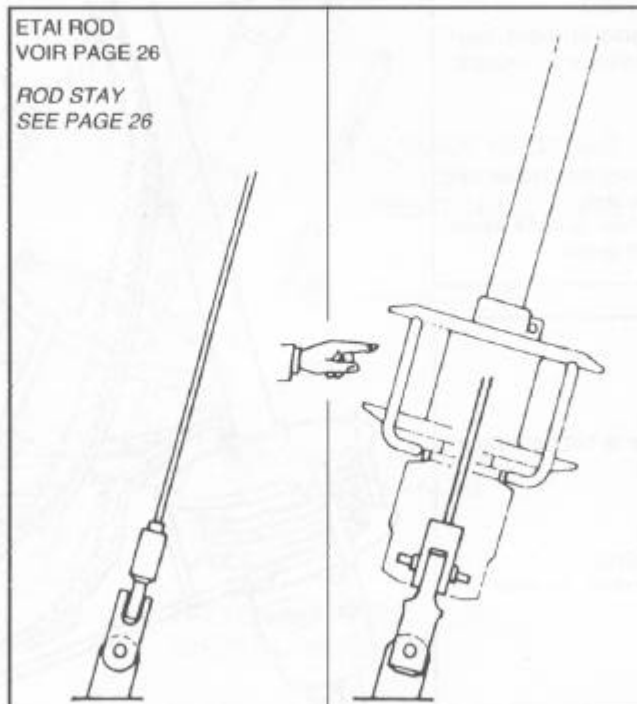
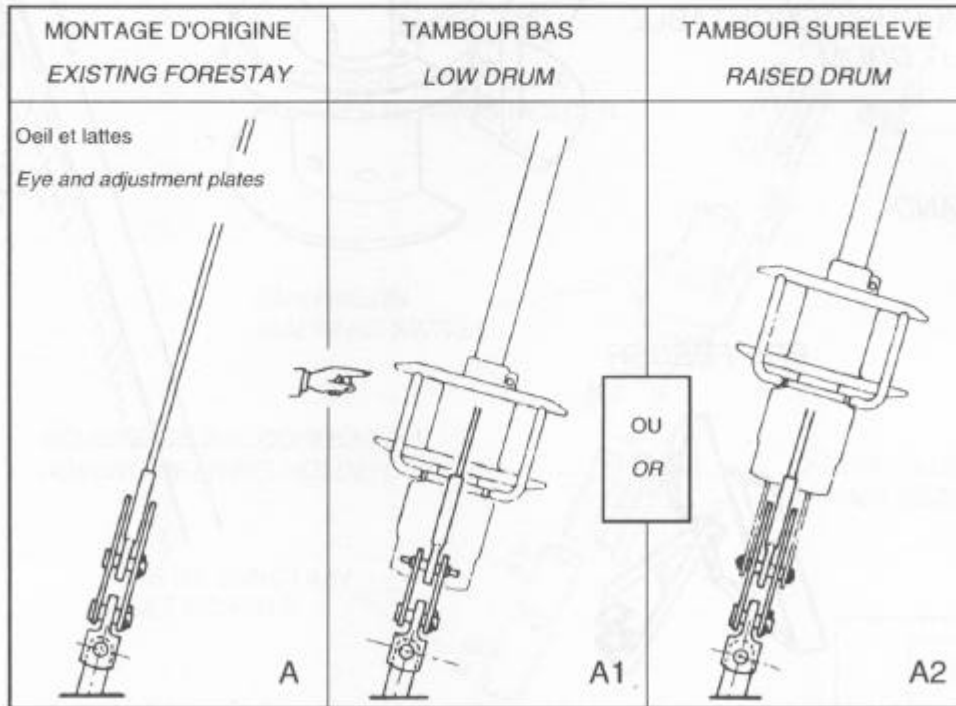

MONTAGE D'ORIGINE AVEC RIDOIR
EXISTING RIGGING SCREW

TAMBOUR BAS
LOW DRUM

TAMBOUR SURELEVE
RAISED DRUM

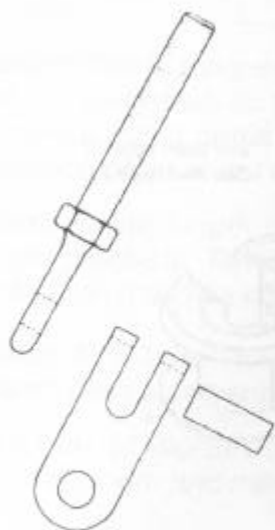

Chape articulée à axe démontable.
Eye and toggle with removable pin.



B

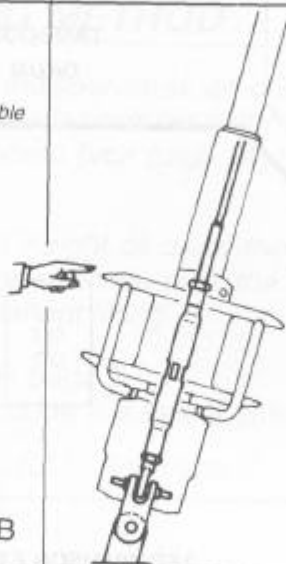

B1

OU
OR

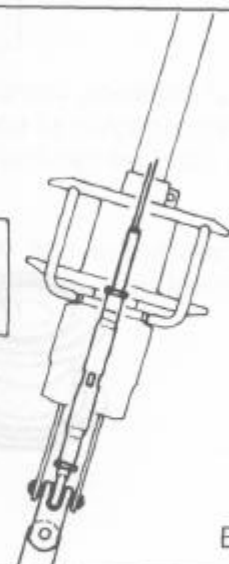

B2

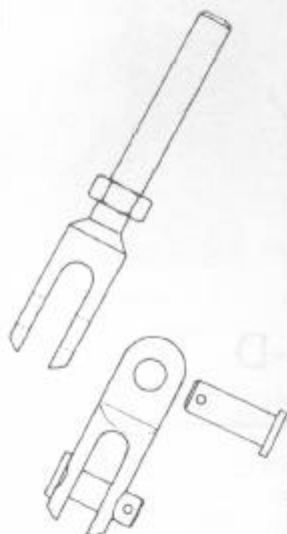

Chape fixe et cardan.
Machined fork and toggle.



C

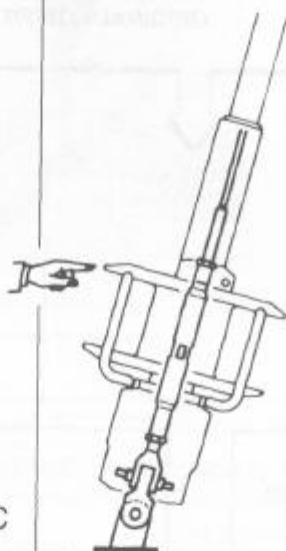

C1

OU
OR

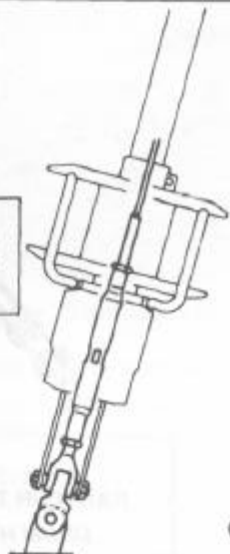

C2

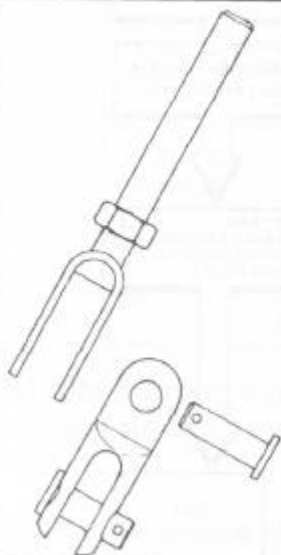

Chape articulée à axe démontable.
Fork and toggle with non removable pin.



D

Pour un montage tambour bas
changer la partie inférieure du
ridoir pour revenir aux cas B ou
C.

If a low drum is desired,
change the lower part of the
rigging screw in order to be back to B or
C.



OU
OR

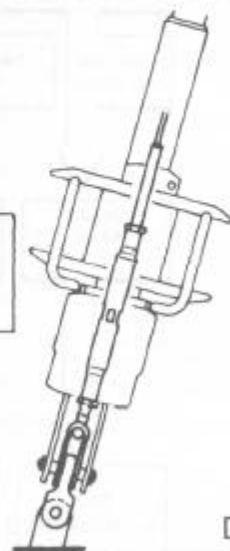

D2

SEQUENCES A SUIVRE POUR LE MONTAGE DU MECANISME INFERIEUR
WHICH SEQUENCES WILL YOU HAVE TO FOLLOW TO FIT YOUR DRUM MECHANISM

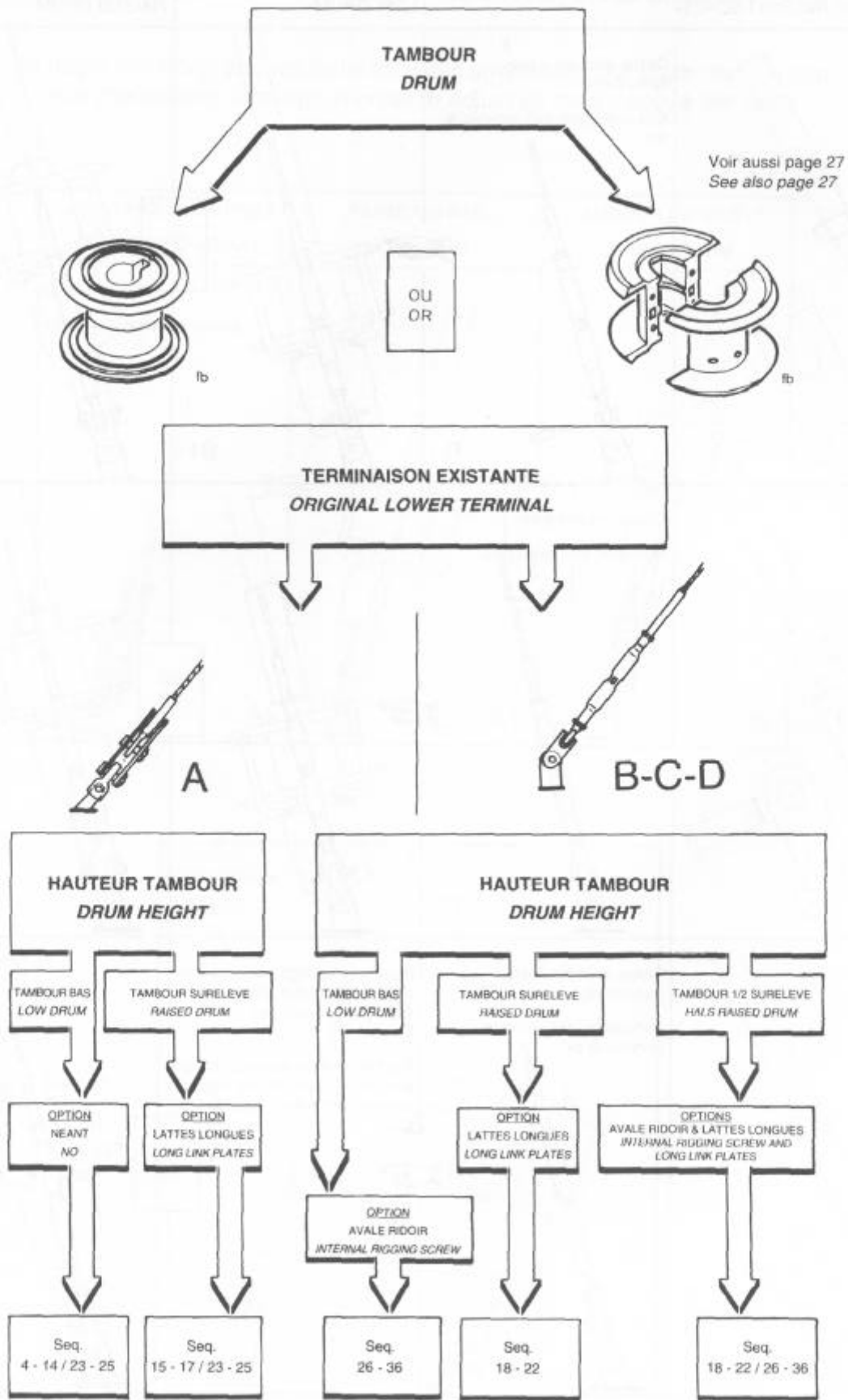

METHODE DE MONTAGE

FITTING METHOD

Pour déterminer la longueur des gaines, il est indispensable de connaître avec précision la hauteur du tambour au-dessus du pont. Il faudra donc provisoirement mettre en place le mécanisme inférieur de l'enrouleur sur la partie inférieure de l'étaï monté (voir page 14) puis le redémonter pour procéder à l'installation proprement dite.

To determine the length of the extrusions, the height of drum mechanism above the deck will be calculated precisely. Temporarily fit the drum mechanism over the original lower stay terminal (see page 14), then unfit it in order to make the permanent fitting.

MONTAGE AVEC LATTES LONGUES (LL) : Voir page 3

Déterminer l'emplacement du perçage et de la coupe à la valeur choisie.

IF OPTIONAL LONG LINK PLATES ARE USED (LL) : See page 3

Cut them to length and mark and drill for the pin.



Seq. 1

Tracez à la hauteur choisie.
Mark according to drum height.

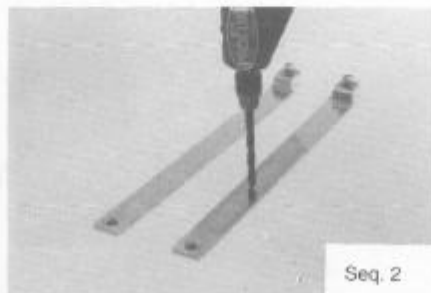

Seq. 2

Percez selon le tableau ci-dessous.
Drill according to hereunder heading.

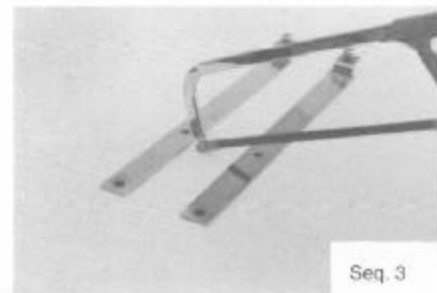

Seq. 3

Couper à env. 20 mm sous le trou et ébavurer la coupe.
Cut at about 20 mm under the hole and trim smooth.

DIAMETRE DE PERÇAGE DES LATTES LONGUES SELON MODELES LONG LINK PLATES DRILLING DIAMETER ACCORDING TO MODELS		
MODELES MODELS	R25 - R25I	Ø 8,3 mm (21/64")
MODELES MODELS	NC32 - LC32I - LC31I C32 - C32I R35 - R35I	Ø 10,3 mm (13/32")
MODELES MODELS	NC42 - NC42I - LC42 - LC42I C42 - C42I R423 - R42I LC42R - LC42IRI	Ø 12,4 mm (31/64")
MODELES MODELS	N52 N52I L52	Ø 15 mm (19/32")

ATTENTION : lors des séquences de coupe ou de perçage de pièces, celles-ci devront être immobilisées par des moyens appropriés, les vues montrées ne présentant qu'un caractère symbolique.

CAUTION: the pictures showing drilling or cutting operations are purely symbolic. Normal safety precautions should be taken to avoid injury.

MODELES } NC-LC
 MODELS } N-L-C-R

MONTAGE DU MECANISME INFERIEUR

LOWER MECHANISM ASSEMBLY

1°) Montage A1 A1 Assembly

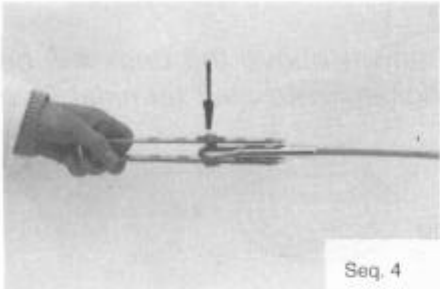

Seq. 4
 Position de l'axe d'origine sur les lattes.
 Existing pin position on the adjustment links.

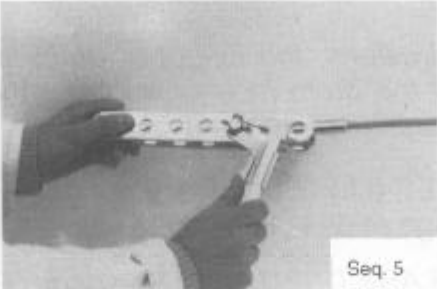

Seq. 5
 Mesurez le diamètre de l'axe.
 Measure existing pin diameter.

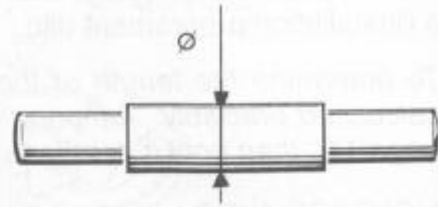

Vérifiez que le Ø de l'axe livré avec l'enrouleur corresponde à celui de l'axe d'origine.

The diameter of the special clevis pin provided with the unit should correspond to the one of the existing pin.

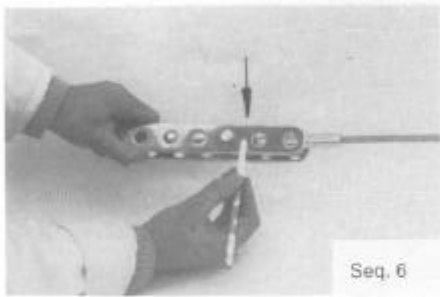

Seq. 6
 Tracez la tangente au trou voisin.
 Mark the tangent to the next upper hole.

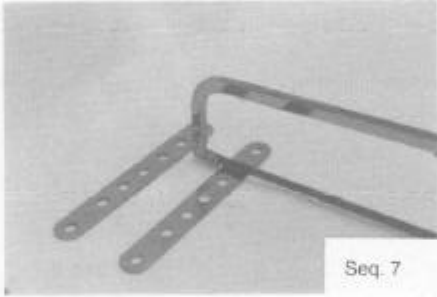

Seq. 7
 Coupez selon le tracé.
 Cut according to the mark.

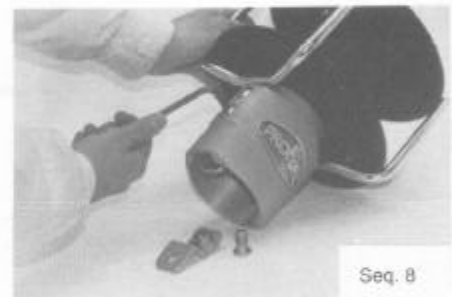

Seq. 8
 Démontez les deux vis de lattes.
 Unfit both link plates set screws.

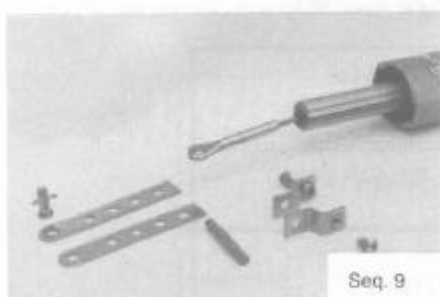

Seq. 9



Seq. 10
 Montez l'axe PROFURL.
 Fit the PROFURL clevis pin.

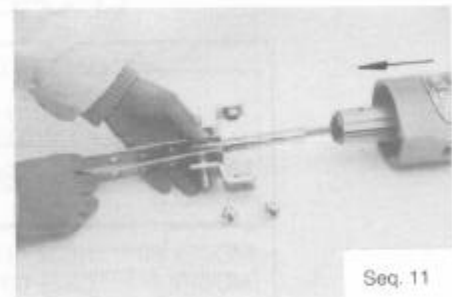

Seq. 11
 Enfillez les deux lattes aux extrémités de l'axe.
 Slide link plates on each pin end.

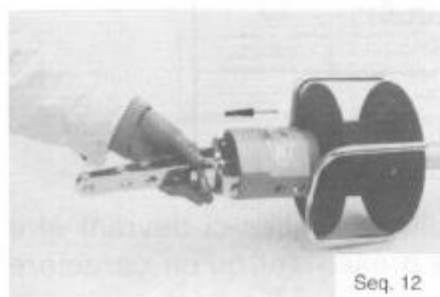

Seq. 12
 Engagez les lattes dans le mécanisme.
 Slide link plates into drum mechanism.

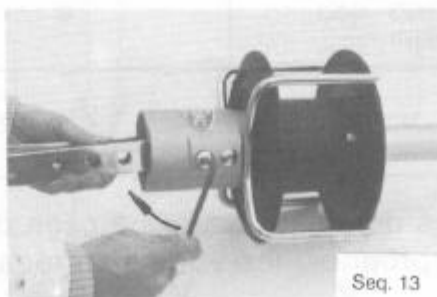

Seq. 13
 Montez les deux vis de lattes.
 Fit two link plates set screws.

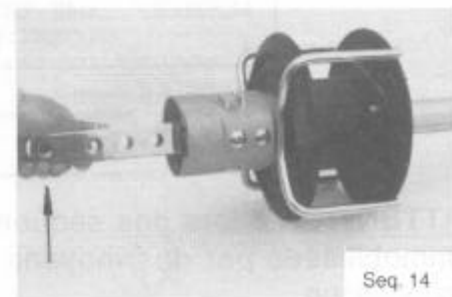

Seq. 14
 Ce trou à la cadène d'étrave, ou sur un cardan ce qui est conseillé.
 This hole to the stemhead, or on a toggle, which we recommend.

2°) Montage A2 A2 Assembly

Avec les lattes longues, on utilise un axe dont les extrémités sont filetées.
With long link plates, the clevis pin ends are threaded.

ATTENTION : lorsque des lattes longues sont utilisées, elles ne doivent en aucun cas être fixées directement sur la cadène d'étrave mais sur l'axe supérieur du cardan.

CAUTION: When long link plates are used, they should never be attached to the stemhead, but to the top of the toggle.

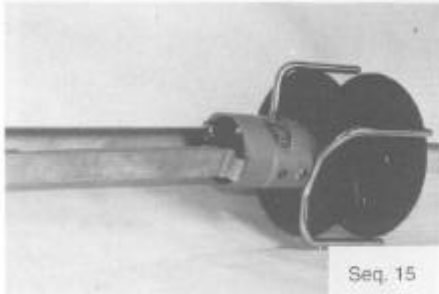

Seq. 15



Seq. 16

Montez les écrous sur l'axe fileté.
Fit the nuts over the threaded pin.

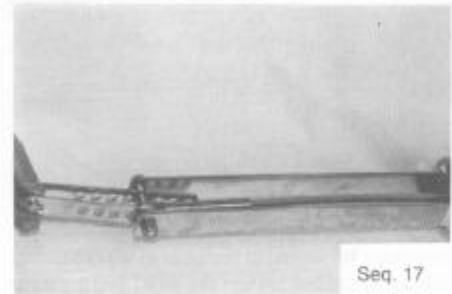

Seq. 17

Ce trou à la cadène d'étrave, ou sur un cardan, ce qui est conseillé.
This hole to the stemhead chainplate or on toggle, which we recommend.

3/ MONTAGE SUR RIDOIR FITING OVER A RIGGING SCREW

MONTAGE B. C. D. B. C. D. ASSEMBLY

Introduisez l'embout fileté du câble dans la gaine et le mécanisme inférieur.
Fit the threaded lower terminal into the lower extrusion and drum mechanism.

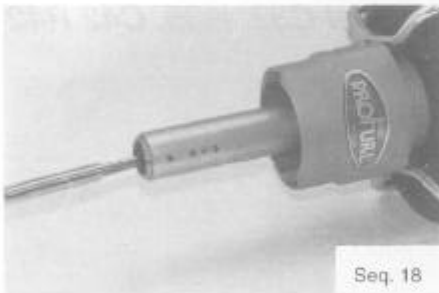

Seq. 18



Seq. 19



Seq. 20

Placez le cardan inférieur sur la terminaison inférieure du ridoir.
Fit the toggle over the lower rigging screw terminal.



Seq. 21

Passez l'axe fileté à travers les lattes et le ridoir.
Fit the thread ended pin through the plates and the rigging screw.

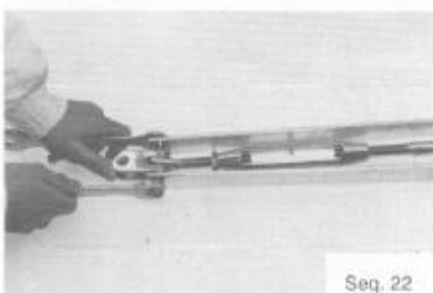

Seq. 22

Placez les rondelles nylon et serrez les écrous.
Fit the nylon washers and tighten the nuts.

Engagez les lattes dans le mécanisme. Idem seq. 35

Slid link plates into drum mechanism. Same as seq. 35

Montage des vis Seq. 13

Screws assembly Seq. 13

1°) Montage A1
 A1 Assembly

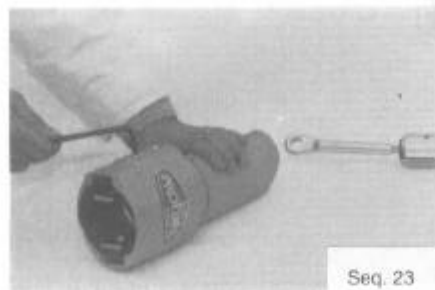

Seq. 23

Démontez les lattes, le tambour et les bras.
 Dismantle the link plates, the drum and the arms.

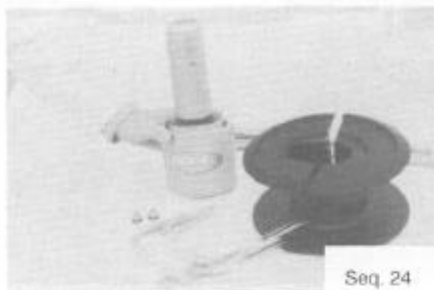

Seq. 24

Montage à suivre Seq. N°4-11
 Next step Seq. N°4-11



Seq. 25

Montage à suivre P. 16

Next step P. 16

MONTAGE AVEC AVALE RIDOIR démontable (modèles C32. R35. C42. R42)
FITTING AN INTERNAL RIGGING SCREW CYLINDER on a model C32. R35. C42.R42



Seq. 26

Dévissez les 3 vis du manchon.
 Unfit the 3 screws.

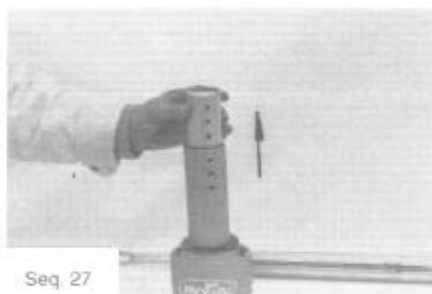

Seq. 27

Déboîtez le manchon.
 Unfit the shape adapter.



Seq. 28

Emboîtez le tube avale ridoir.
 Assemble the cylinder.

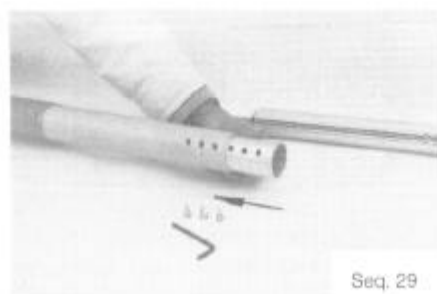

Seq. 29

Emboîtez le manchon d'adaptation.
 Fit the shape adapter.



Seq. 30

Montez et serrez les vis.
 Fit and tighten the screws.

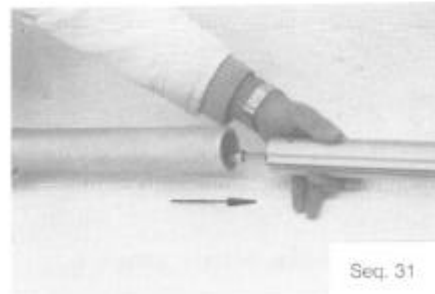

Seq. 31

Enfilez la gaine inférieure dans le tube.
 Fit the lower extrusion into the cylinder.



Seq. 32

Réassemblez le ridoir, l'axe et le cardan.
Fit the rigging screw, the pin and the toggle.

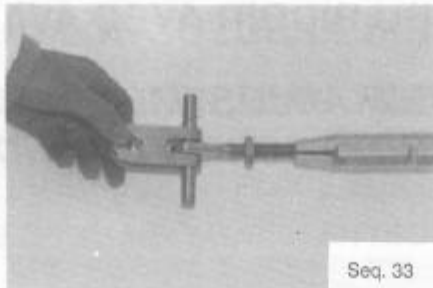

Seq. 33



Seq. 34

Enfilez les lattes à l'extrémité de l'axe.
Fit the link plates on the pin ends.



Seq. 35

Glissez les lattes dans le mécanisme.
Slide link plates into drum mechanism.



Seq. 36

Serrez les vis de lattes.
Tighten the link plates set screws.

Montage à suivre Seq. 53.
Next step Seq. 53.

REGLAGE DU RIDOIR AVEC DES LATTES LONGUES.

RIGGING SCREW ADJUSTMENT WITH LONG LINK PLATES.



Seq. 38

Dévissez les vis de lattes.
Unfasten the link plates set screws.

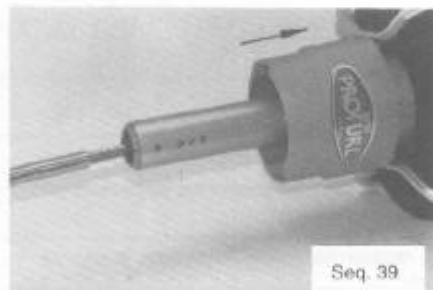

Seq. 39

Glissez le mécanisme vers le haut.
Slide up the drum mechanism.

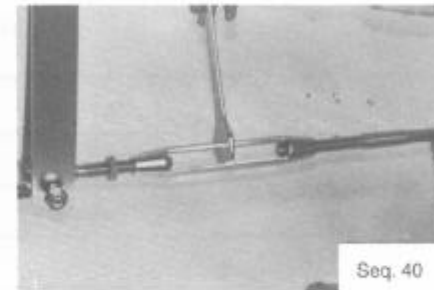

Seq. 40

Régler le ridoir.
Adjust rigging screw.

Pour réassembler, suivez les séquences en ordre inverse.
To reassemble, follow instructions in reverse order.

REGLAGE DU RIDOIR AVEC AVALE RIDOIR

RIGGING SCREW ADJUSTMENT WITH INTERNAL RIGGING SCREW CYLINDER

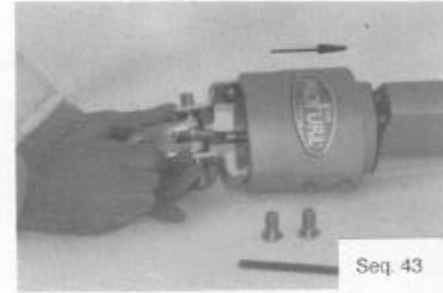
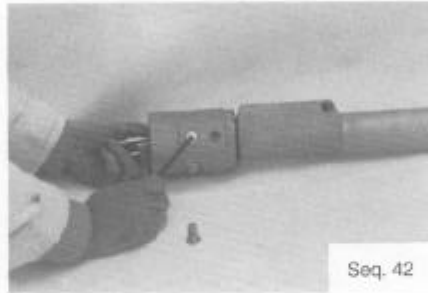
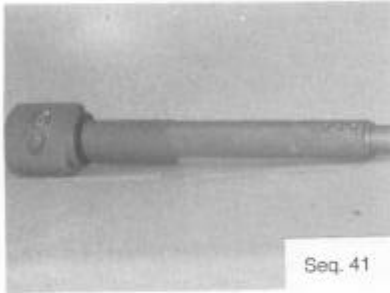

Démontez les vis de lattes.
Unfasten the link plates set screws.

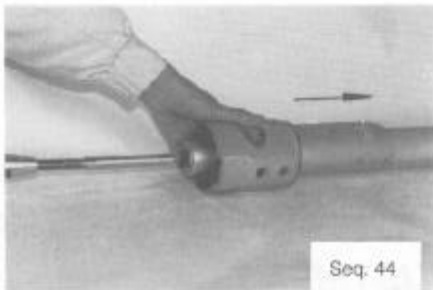

Glissez le mécanisme vers le haut.
Slide up the drum mechanism.

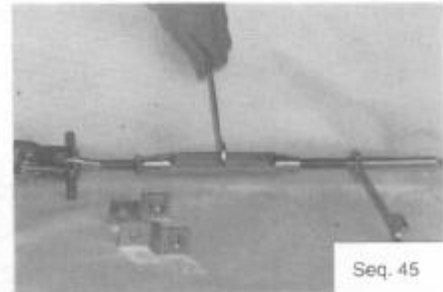

Régler le ridoir.
Adjust rigging screw.

Pour réassembler, suivez les séquences en ordre inverse.

To reassemble follow instructions in reverse order.

TOUS MODELES
ALL MODELS

MISE A LONGUEUR DES GAINES CUTTING EXTRUSIONS TO LENGTH

1°) MESURE DE L, MECANISME INFERIEUR EN PLACE SUR L'ETAI.

L MEASUREMENT WITH THE DRUM MECHANISM FITTED ON THE STAY.

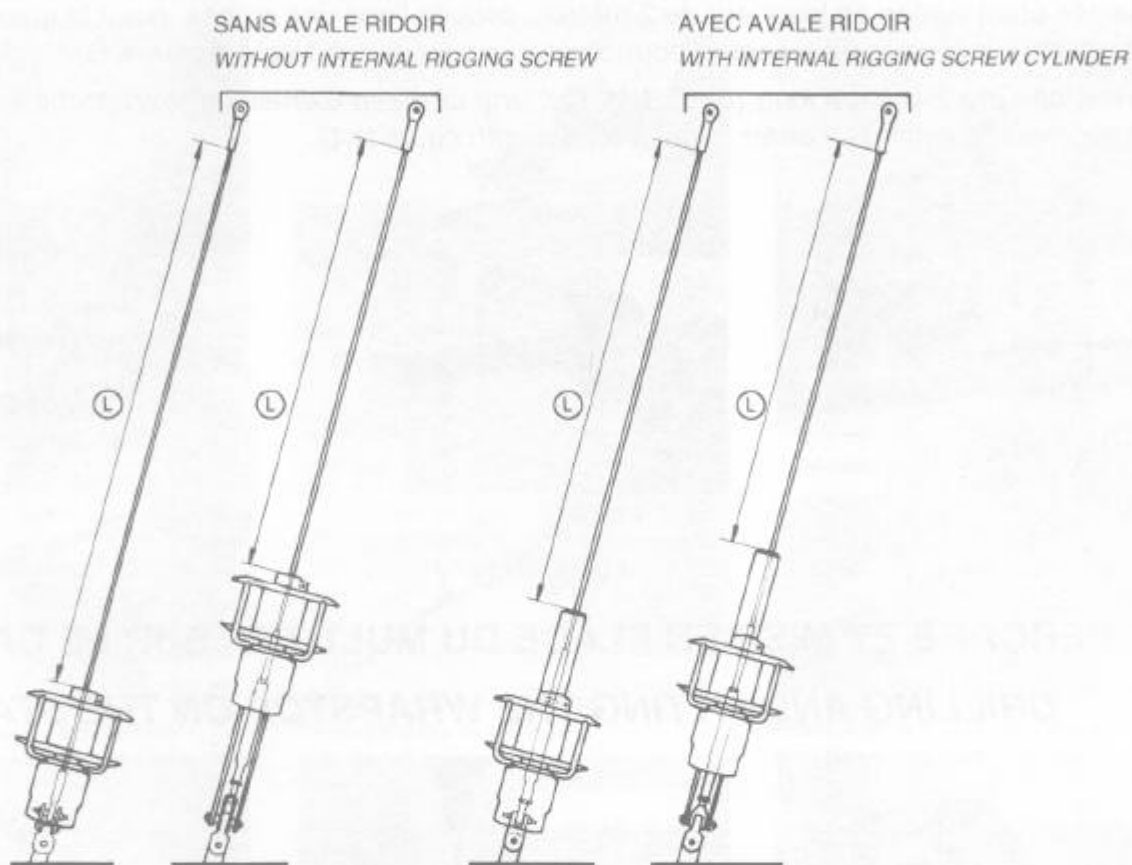

2°) CALCUL DE LA LONGUEUR DES GAINES G.

HOW TO DETERMINE THE TOTAL LENGTH G OF EXTRUSIONS.

MODELES / MODELS	L	AJOUTER	= G
R25 - R25I	+ 20 mm (3/4")	=
NC32 - NC32I	+ 0 mm	=
LC32 - LC32I	+ 0 mm	=
C32 - C32I - R35 - R35I	+ 15 mm (19/32")	=
NC42 - NC42I	+ 25 mm (1")	=
LC42 - LC42I	+ 25 mm (1")	=
C/R42 - C/R42I	+ 20 mm (25/32")	=
LC42R - LC42RI	+ 25 mm (1")	=
N52 - N52I - L52	+ 50 mm (2")	=

TOUS MODELES
ALL MODELS

DEMONTEZ LE MECANISME DE L'ENROULEUR ET L'ETAI EN TOTALITE UNFIT THE DRUM MECHANISM AND THE FORESTAY

3°) MISE A LONGUEUR DES GAINES. CUTTING EXTRUSIONS TO LENGTH.

Les gaines étant livrées en longueur de 2 mètres, coupez l'une des gaines, (sauf la gaine inférieure qui comporte l'engoujure de ralingue) pour obtenir une longueur totale égale à G.

All extrusions are 2 meters long (6' 6" 3/4). Cut any of these extrusions (except the lower extrusion with the groove opening), in order to get a total length equal to G.

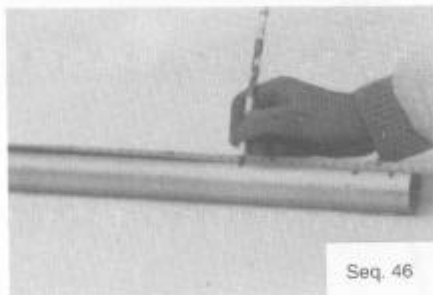

Seq. 46

Tracez G.
Mark G.

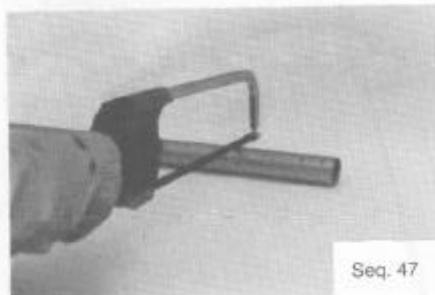

Seq. 47

Coupez selon G.
Cut according to G.

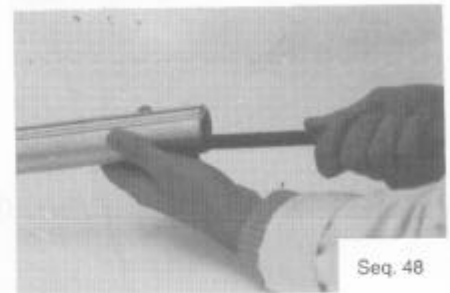

Seq. 48

Ebavurez la coupe.
Trim smooth.

PERÇAGE ET MISE EN PLACE DU MULTITOP SUR LE CABLE DRILLING AND FITTING THE WRAPSTOP ON THE STAY

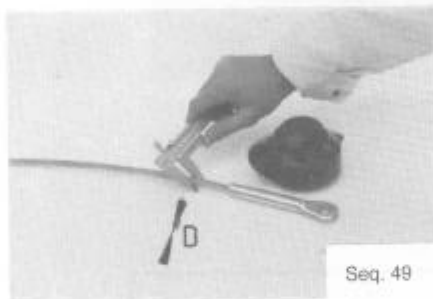

Seq. 49

Mesurez le diamètre du câble (D).
Measure the wire diameter (D).

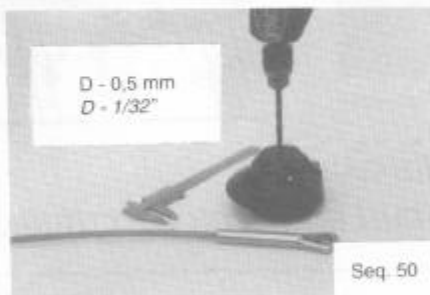

Seq. 50

Percez le multitop à D -0,5 mm.
Drill the wrapstop at D -0,5 mm.

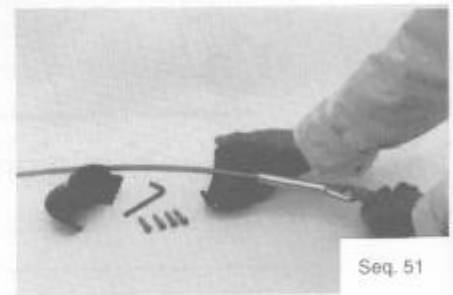

Seq. 51

Montez le multitop sous le sertissage.
Fit the wrapstop under the upper terminal.

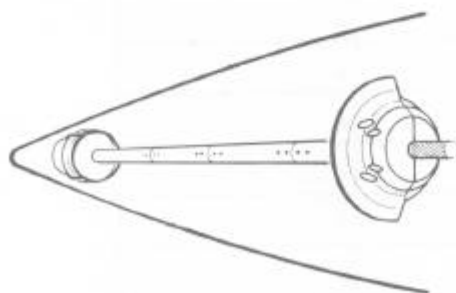

Le multitop sera orienté sur l'étau pour obtenir cette disposition.
Make sure that the wrapstop is properly orientated in order to get this arrangement.

Serrez les vis.
Tighten the set screws.

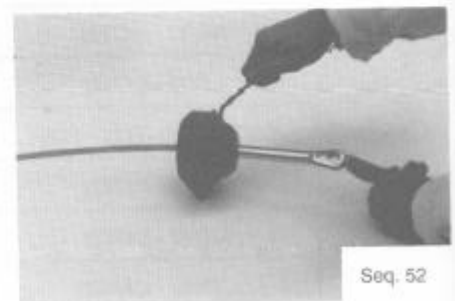

Seq. 52

Note : le multitop pour modèles 25 - 31 - 32 - 35 ne comporte que 2 vis.

Note : the wrapstop for models 25 - 31 - 32 - 35 has only 2 set screws.

TOUS MODELES
ALL MODELS

MONTAGE DES GAINES FITTING THE EXTRUSIONS

1°) Mise en place de l'éclisse supérieure.

Fitting the upper bearing holder.

Rainure
Slot

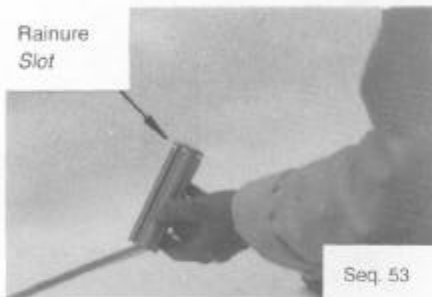

Seq. 53

Prendre l'éclisse supérieure.
Take the upper bearing holder.



Seq. 54

Mettre 1/2 palier dans l'éclisse.
Fit one half bearing into the bearing holder.

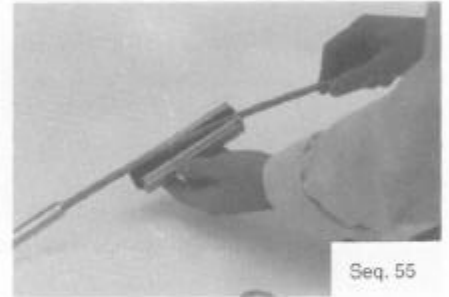

Seq. 55

Placez le câble dans cet ensemble.
Fit the wire into this assembly.

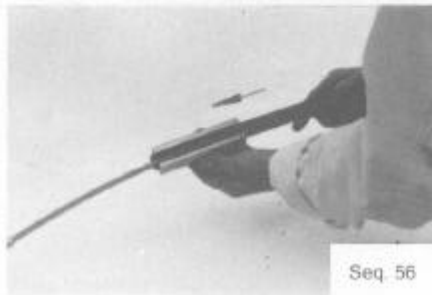

Seq. 56

Glissez le 2e demi-palier dans l'éclisse.
Slide the 2nd half bearing into the bearing holder.

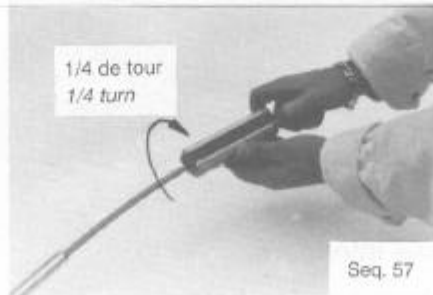

1/4 de tour
1/4 turn

Seq. 57

Tournez le palier de 1/4 de tour.
Turn bearing by 1/4 turn.

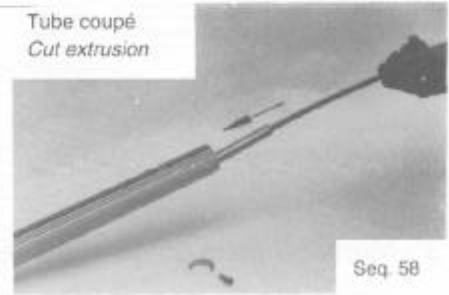

Tube coupé
Cut extrusion

Seq. 58

Enfilez le câble dans la gaine coupée.
Slide the wire into the cut extrusion.

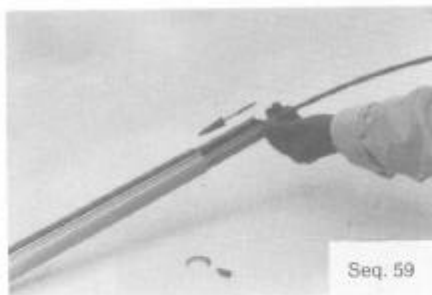

Seq. 59

Poussez l'éclisse supérieure dans la gaine.
Push upper bearing holder into the extrusion.

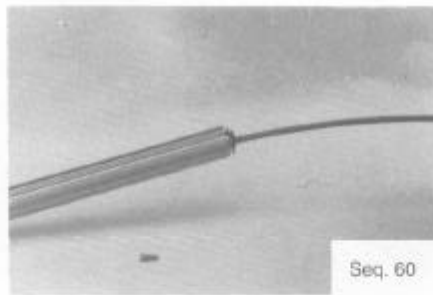

Seq. 60



Seq. 61

Engagez la demi-lune dans la rainure.
Fit the crescent shaped washer into the slot.

Engagez la vis autotaraudeuse dans l'une des gorges.

Fit the self-tapping screw into any groove.

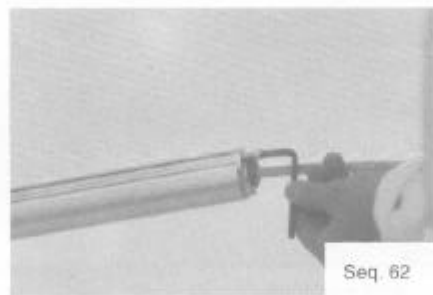

Seq. 62

Serrez

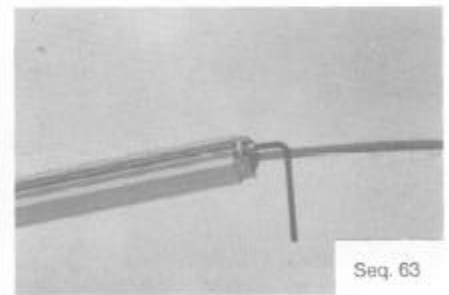

Seq. 63

Tighten

**TOUS MODELES
ALL MODELS**

2°) Jonctions entre les gaines. *Fitting the couplings between extrusions.*

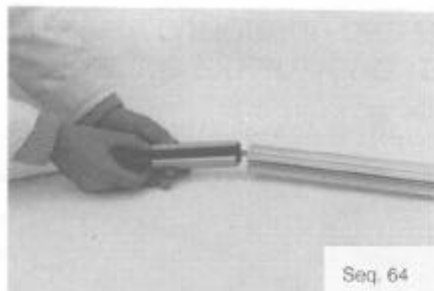

Seq. 64

Montez le palier sur l'éclisse (Seq.54 à 57).
Fit the bearing on the coupling (Seq.54 to 57).

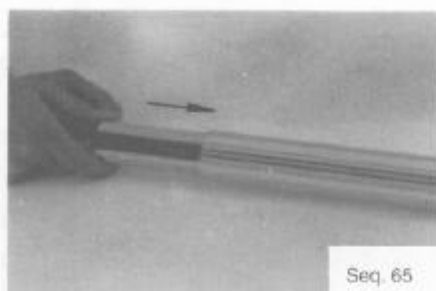

Seq. 65

Poussez la jonction jusqu'à la butée.
Push the coupling to the stop.



Seq. 66

Assemblez avec la gaine voisine.
Fit with the next extrusion.

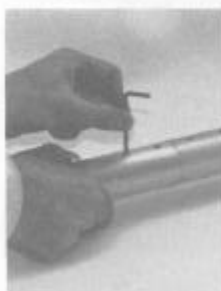

Appliquez quelques gouttes
du produit fourni sur le filetage
*Please coat thread with
Loctite supplied*

Seq. 67

Montez les vis de jonction.
Fit the set screws.

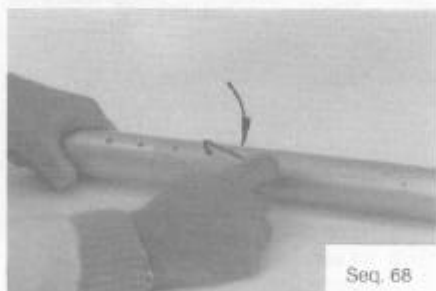

Seq. 68

Amenez les vis juste au contact.
Tighten till screw is touching.



Seq. 69

Serrez d'1/4 de tour.
Tighten by 1/4 turn.

3°) Montage de la gaine et de l'éclisse inférieure. *Fitting the lower extrusion and lower bearing holder.*

Gaine inférieure : ouverture de la gorge vers le bas de l'enrouleur.
Lower extrusion : opening of the groove downwards.

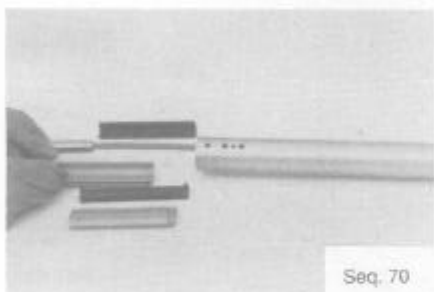

Seq. 70

Placez 1/2 palier dans 1/2 éclisse.
Fit 1/2 bearing into 1/2 bearing holder.



Seq. 71

Glissez dans la gaine inférieure.
Slide into the lower extrusion.

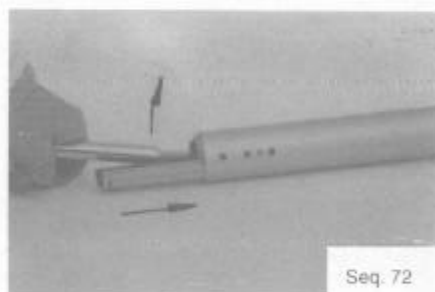

Seq. 72

Poussez le câble de côté.
Push the terminal on the side.

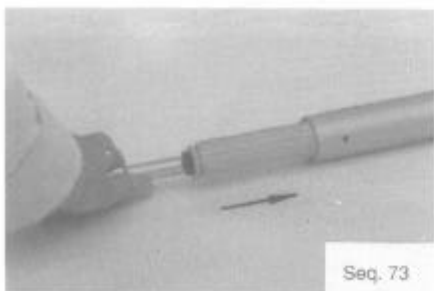

Seq. 73

Poussez le 2e 1/2 éclisse.
Push the 2nd 1/2 bearing holder.



Seq. 74

Le câble est centré.
Stay is centered in extrusion.



Appliquez quelques gouttes
du produit fourni sur le filetage
*Please coat thread with
Loctite supplied*

Seq. 75

Serrez les vis de jonction.
Tighten the set screws.

TOUS MODELES
ALL MODELS

MONTAGE DE L'EMERILLON FITTING THE HALYARD SWIVEL



Seq. 81

Enfilez la latte dans l'émérillon.
Slide the halyard link plate.

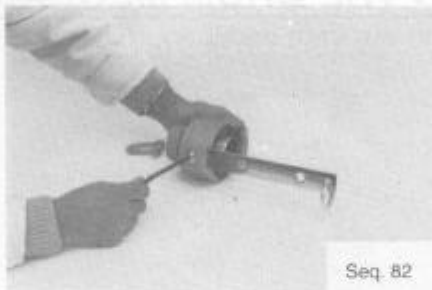

Seq. 82

Serrez la vis.
Tighten the screw.

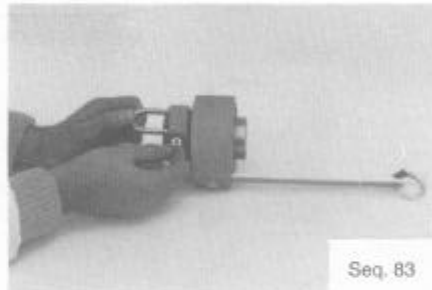

Seq. 83

Montez la manille.
Fit the head shackle.



Seq. 84

Enfilez l'emerillon dans la gaine inférieure.
Slide the halyard swivel over the lower extrusion.

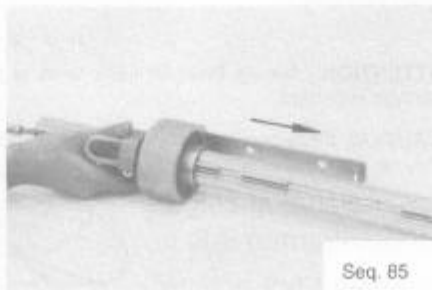

Seq. 85

MONTAGE DU GUIDE RALINGUE (modèles C-R) FITTING THE FEEDER (models C-R)



Seq. 89

Pincez les broches en les engageant dans les gorges.
Pinch the nails and slide them down into the grooves.



Seq. 90

Relâcher pour verrouiller.
Release to lock

MODELES } NC - LC
 MODELS } N - L

FIXATION DE LA GAINÉ INFERIEURE SUR LE MECANISME INFERIEUR

FITTING THE LOWER EXTRUSION ON THE DRUM MECHANISM

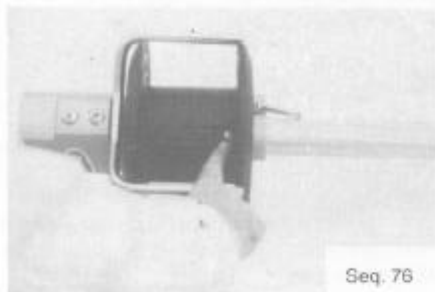

Seq. 76

Démontez l'une des deux vis.
 Remove one of drum screws.

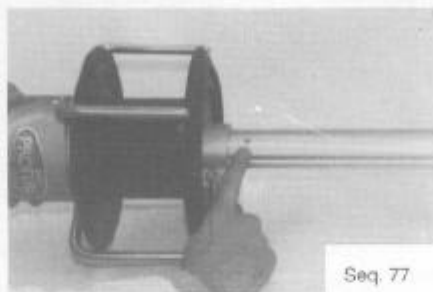

Seq. 77

Alignez le trou avec le trou lisse situé en bas de la gaine inférieure.
 Line up this hole with the smooth hole of the lower extrusion.

La gaine inférieure comporte un trait permettant de visualiser la hauteur d'encastrement exacte de la gaine dans le mécanisme.

The lower extrusion has a mark which allows to control how high the extrusion penetrates in the drum mechanism.



Seq. 78

Serrez la vis opposée puis montez la première vis.
 Tighten the opposite screw then fit the first screw.

ATTENTION : les vis étant freinées dans le plastique du tambour, elle ne demandent pas un serrage important.

CAUTION: these two screws should be tightened cautiously as they self tap in the drum plastic and they do not require hard tightening.

MODELES } C - R
 MODELS }

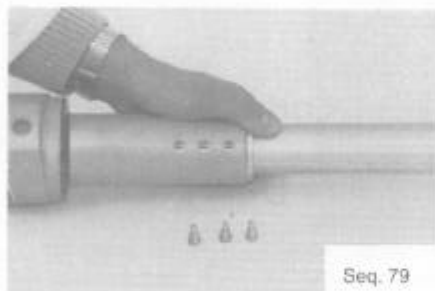

Seq. 79

Alignez les 2 ou 3 trous (selon modèle) lisses de la gaine inférieure avec les 2 ou 3 trous filetés du mécanisme inférieur et montez les 2 ou 3 vis.
 Line up the 2 or 3 smooth holes (according to model) of the bottom extrusion with the 2 or 3 threaded holes of the drum mechanism, and fit the 2 or 3 screws.

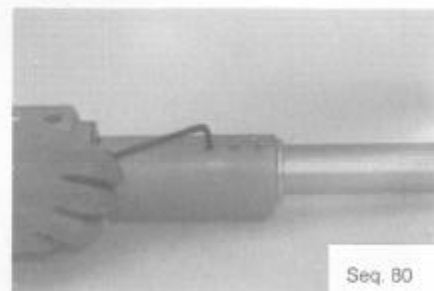

Seq. 80

N. B. 2 vis sur modèles R25 - C32 - R35
 2 screws on models R25 - C32 - R25
 3 vis sur modèles C42 - R42
 3 screws on models C42 - R42

MODELES } N52 - N521
 MODELS } L52

Le tambour est fixé tel que Seq.78 et la gaine inférieure est fixée sur le mécanisme inférieur tel que Seq.79 et 80, avec 2 vis.
 The plastic drum is secured as shown Seq.78, and the lower extrusion is secured on top of the drum mechanism Seq.79 & 80 with 2 screws.

TOUS MODELES
ALL MODELS

INSTALLATION A BORD / FITTING ON BOARD

Ne pas installer par fort vent.

Veillez à ne pas cambrer exagérément les gaines lors des manipulations.

Do not attempt in strong winds.

Do not bend the extrusions too much when they are on a loose stay.

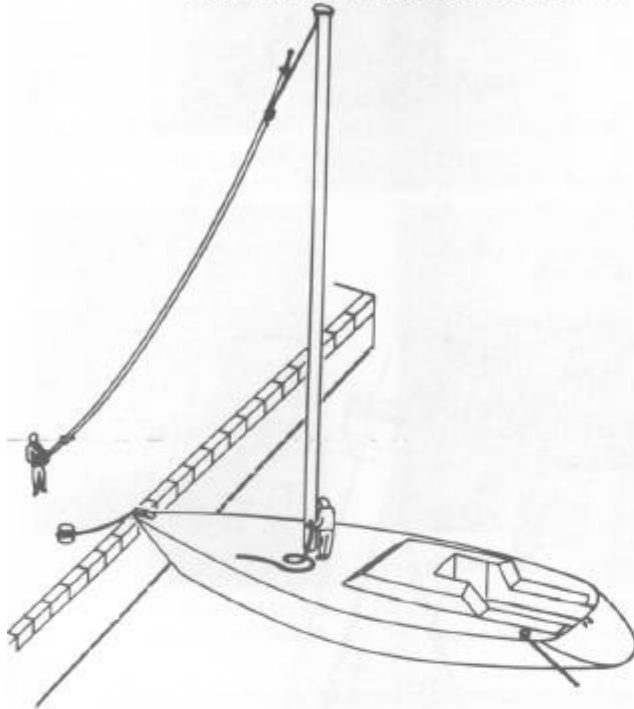

Avant de capeler la terminaison supérieure de l'étai sur la tête de mât, vérifiez que le multitop est correctement orienté tel que décrit page 17.

Before attaching the top of the stay to the masthead, make sure that the wrapstop is properly orientated as shown page 17.

Réglez la tension (de l'étai et) du pataras jusqu'à obtenir un étai normalement tendu.

Tension the forestay and backstay to get a tight forestay.

MISE EN PLACE DU CORDAGE DE MANOEUVRE MODELES

FITTING THE REEFING LINE MODELS

NC - LC - N - L

Utilisez du cordage : Ø 8 mm pour les modèles 25, 32 et 35.

Ø 10 mm pour les modèles 42 et 52.

Use Ø 8 mm (5/16") line for models 25, 32 and 35.

Ø 10 mm (3/8") line for models 42 and 52.

MODELES }
MODELS } NC - LC - N - L

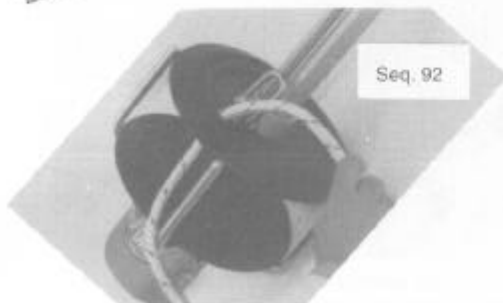

MODELES } C-R
 MODELS }



Seq. 94



Seq. 95



Seq. 96

Montez les bras.
 Fit the arms.



Seq. 97

Montez 2 demi-tambours.
 Fit the 2 half drums.

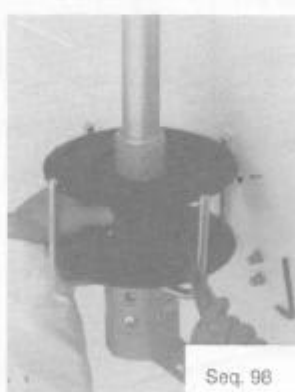

Seq. 98

Vissez les 4 vis d'assemblage.
 Screw the 4 drum set screws.



Seq. 99

Serrez les vis de bras.
 Fit the arms screws.

TOUS MODELES
 ALL MODELS

Le sens de l'enroulement est indifférent, mais sera défini en fonction du côté où la bande UV est placée sur la voile.
 The direction of furling is not important, but will be determined according to the side where the UV strip is sewn on the sail.



Seq. 100

Chargez le tambour en cordage.
 Fill the drum with line.

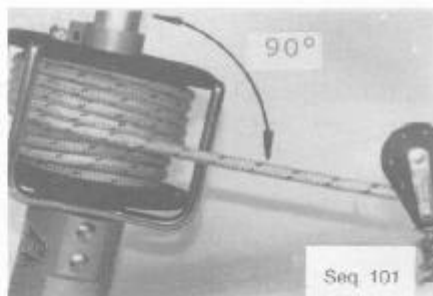

Seq. 101

Réglez la distance de la première poulie; pour obtenir un angle de 90° à mi hauteur du tambour.
 Adjust the distance of the first block on deck to get a 90° angle at midheight of the drum.

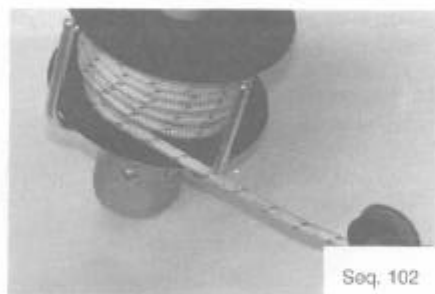

Seq. 102

Bon.
 Good.

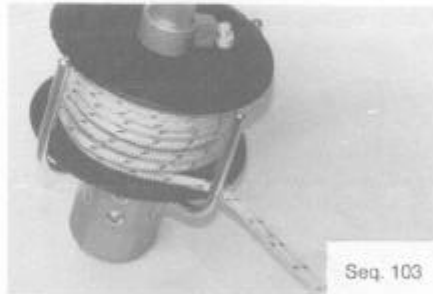

Seq. 103

Mauvais (le cordage touche un bras).
 Bad (the line is touching an arm).

HISSER LA VOILE HOISTING THE SAIL

Attachez la drisse sur l'anneau de la latte d'émérillon.
Fasten the halyard on the ring of the swivel plate.

MODELES	} C - R
MODELS	

Passez la ralingue dans le pré-guide ralingue (modèles C et R uniquement) puis dans le guide ralingue.

Slide the luff tape into the pre-feeder (models C and R only) then into the feeder.

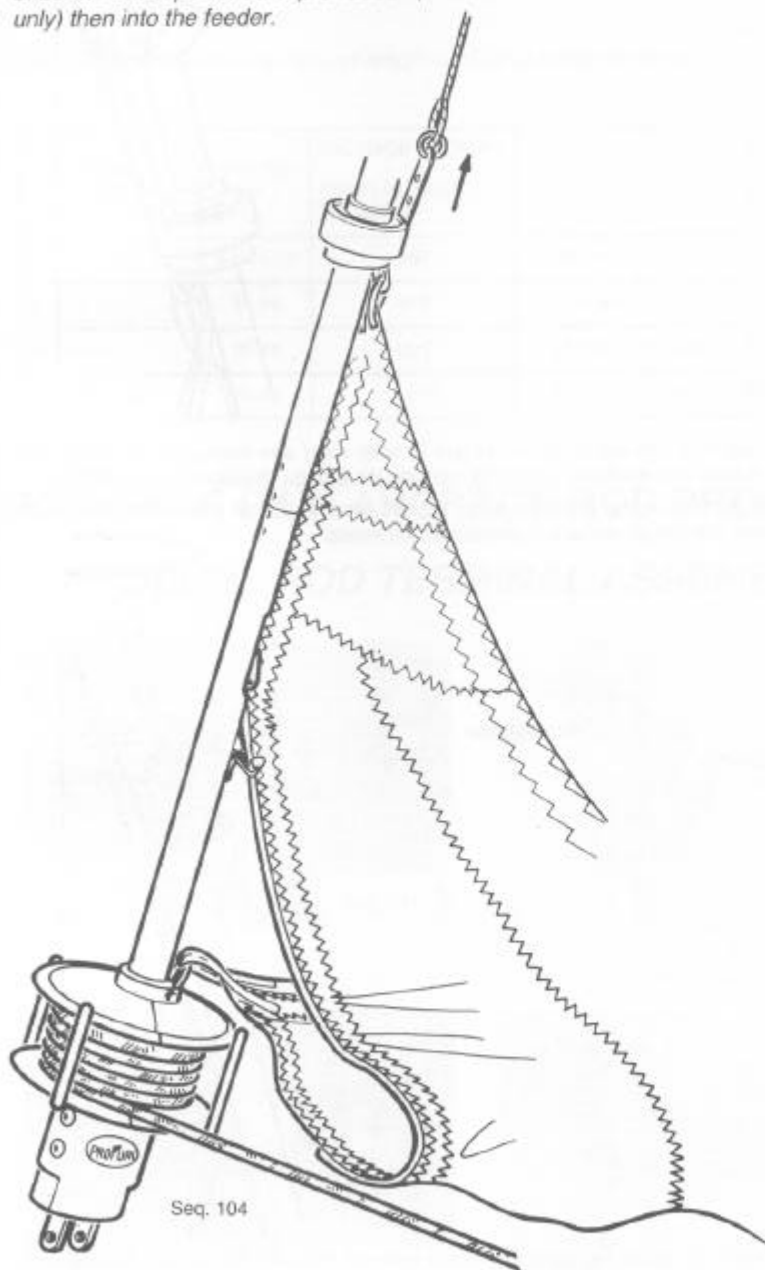

MODELES	} N - L 52
MODELS	

Passez la ralingue dans le guide ralingue.

Slide the luff tape into the feeder.

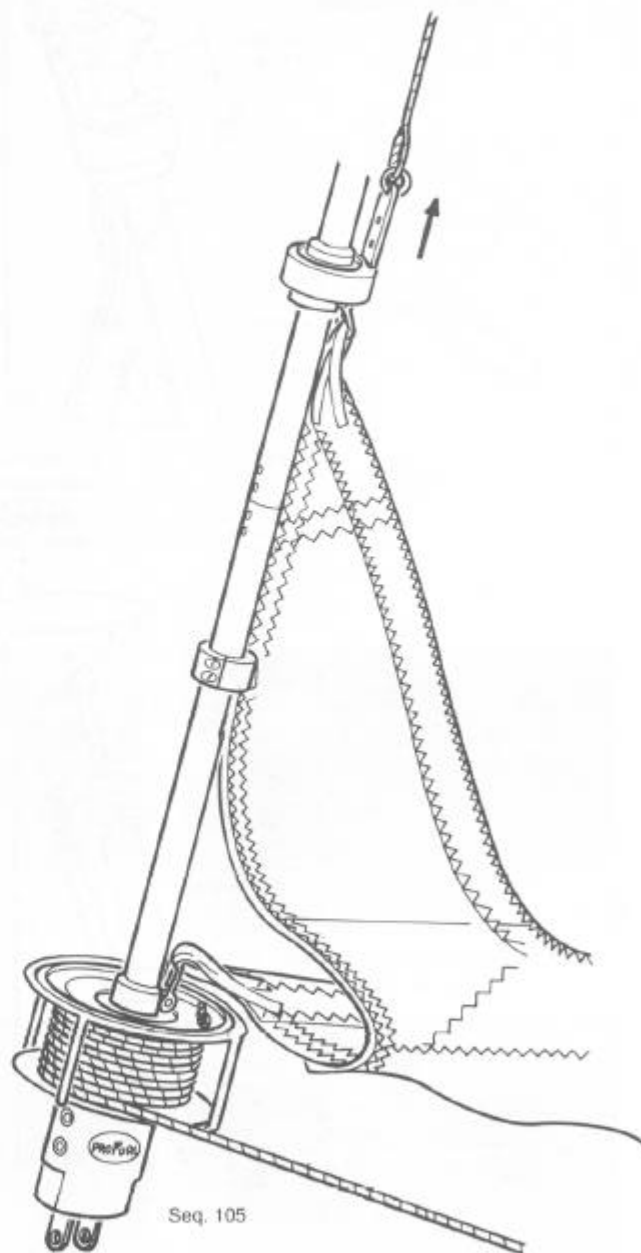

Note : les modèles N et L de la gamme CLASSIC ne comportent pas de pré-guide ralingue.

Models N and L of CLASSIC line have no pre-feeder.

TOUS MODELES
ALL MODELS

REGLAGE DE L'EMERILLON HALYARD SWIVEL ADJUSTEMENT

- BON** 1°) L'anneau est situé au dessus du multitop.
2°) Il subsiste un espace de 5 à 10 cm entre le haut de l'émerillon et le haut de la gaine.

- GOOD** 1°) The ring is above the wrapstop.
2°) There is a space of 5 to 10 cm from the top of swivel to the top of extrusion.

5-10cm
2"-4"

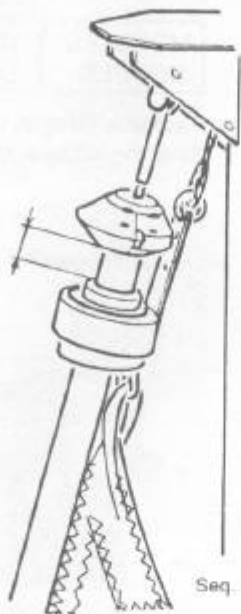

Seq. 106



Seq. 107

Si l'émerillon est trop bas sur la gaine, et que la voile n'est pas étarquée, utilisez le trou supérieur sur la latte d'émerillon et, coupez le morceau de latte qui dépasse sous l'émerillon.

If the swivel is too low on the extrusion when the luff is not tight, use the higher hole on the halyard link plate and cut off any spare underneath the swivel.

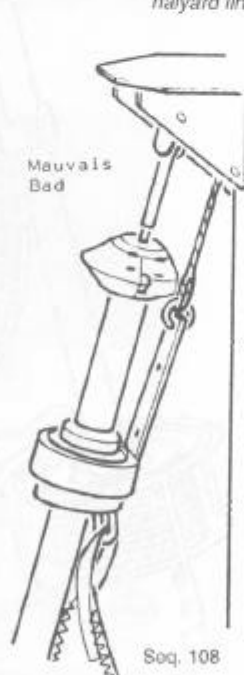

Seq. 108



Seq. 109

Si l'émerillon est trop bas sur les gaines et que la voile est étarquée placez une estrope entre la tête du génou et l'émerillon.

If the swivel is too low on the extrusion although the luff is tight, use a pennant between the genna head and the halyard swivel.

TOUS MODELES
ALL MODELS

MONTAGE SUR UN ETAI EN ROD ASSEMBLY ON A ROD HEADSTAY

La terminaison spéciale PROFURL sera placée à la partie inférieure de l'étau.
The special PROFURL rod terminal should be used.

Terminaison supérieure standard.
Standard upper terminal.

Pour calculer la longueur du rod à l'exclusion de la terminaison inférieure
utilisez la table ci-dessous.

Use the table to calculate the rod length excluding lower terminal.

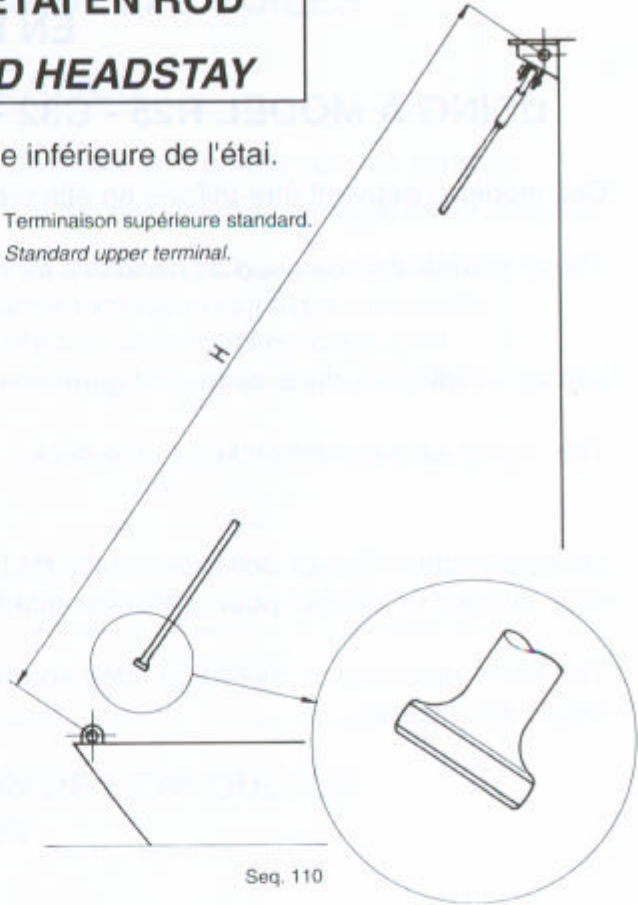

Ø Rod mm	NAVTEC #	ANCRAGE PROFURL PROFURL ROD TERMINAL	H —
5-6-7	6-8-10-12	567	87 mm - 3" 27/64"
8-10	17-22	810	111 mm - 4" 3/8"
11,2-12,7	30-40	1112	133 mm - 5" 15/64"
14,3-16,8	48-60	1416	188 mm - 7" 13/32"

MONTAGE D'UN ANCRAGE ROD PROFURL PROFURL ROD TERMINAL ASSEMBLY

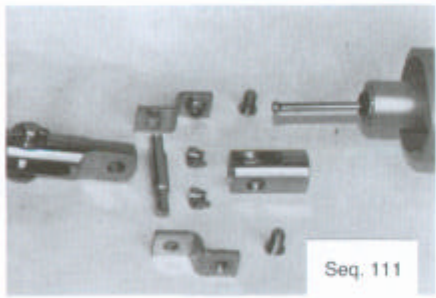

Seq. 111

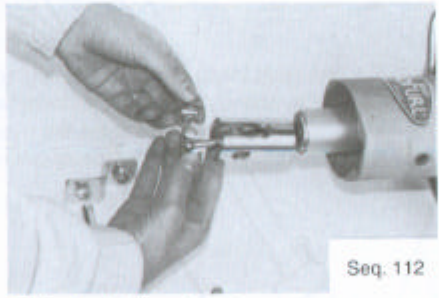

Seq. 112

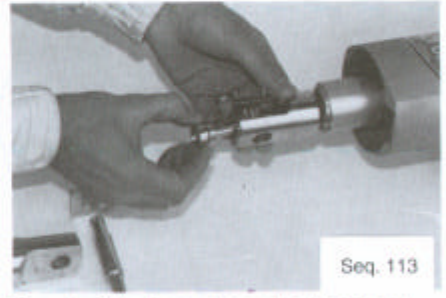

Seq. 113

Enfilez la douille sur le rod.
Fit the body on the rod head.

Posez le 2 demi-coquilles sur la tête de rod.
Fit the half lock nuts on the rod head.

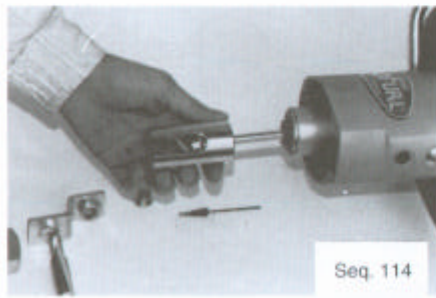

Seq. 114

Verrouillez en tirant.
Lock by pulling.

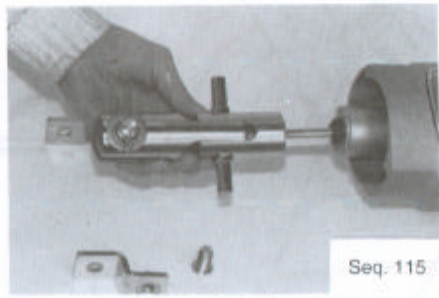

Seq. 115

Passez l'axe sur la douille et le cadran.
Fit the pin on the body and the toggle.

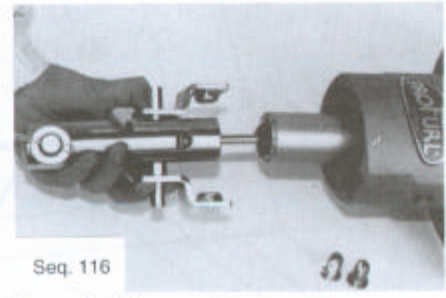

Seq. 116

Passez les lattes sur l'axe.
Slide link plates on pin ends.

UTILISATION D'UN MODELE R25 - C32 - R35 - C42 - R 42 EN ETAI CREUX.

USING A MODEL R25 - C32 - R35 - C42 - R42 AS A RACING FOIL.

Ces modèles peuvent être utilisés en étai creux après démontage du tambour et des bras.

These models can be used as headfoils for racing, by removing the drum and the arms.

Les voiles utilisées dans cette configuration peuvent être amurées directement sur le pont.

The racing sails can be tacked to the deck.

Le mécanisme inférieur doit être installé de façon à ce que les vis du mécanisme soient situées sur le côté. Utilisez un cardan pour réaliser le quart de tour si nécessaire.

The lower mechanism should be fitted so that the arms and link plates screws are on the side. Use a toggle if necessary.

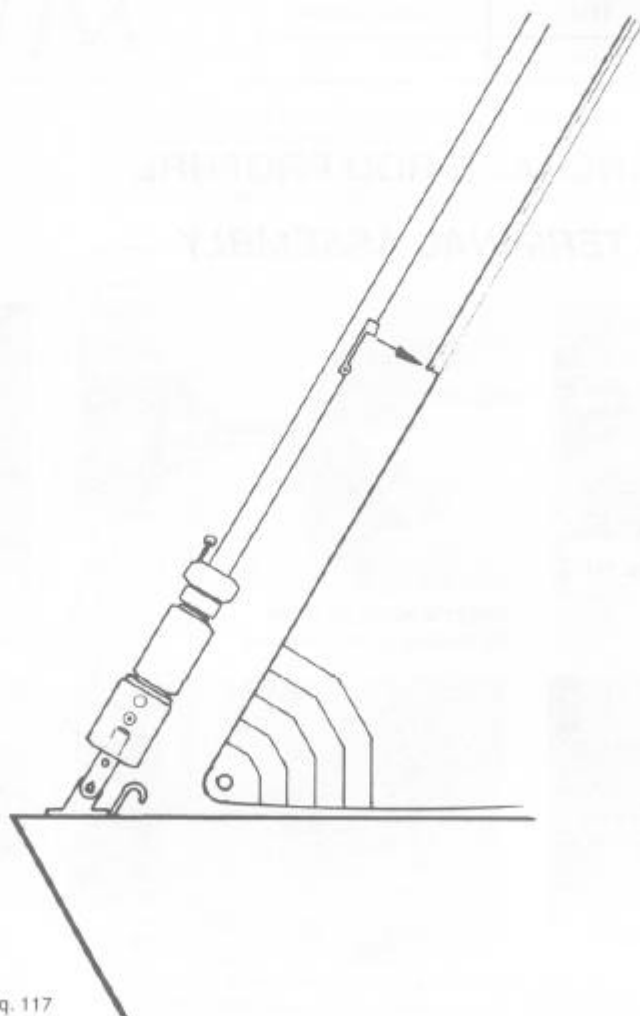

Seq. 117

SPECIFICATION CONCERNANT LES VOILES

SAILS SPECIFICATION

Nous vous conseillons de réaliser le montage des points de drisse et d'amure sur des sangles.

We recommend to use webbing on the head and the tack of the sail, to allow furling without cringles.

MODELES MODELS	DIAMETRE EXTERIEUR DES RALINGUES FINIES LUFF TAPE DIAMETERS (FINISHED SIZE)
R25 NC32 - NC32I LC32 - LC32I NC42 - NC42I LC42 - LC42I C42 - C42I R42 - R42I LC42R - LC42RI	5 mm (13/64") (U.S. # 6)
N52 - N52I L52	6 mm (15/64") (U.S. # 7)

CONSEIL POUR L'UTILISATION DE L'ENROULEUR OPERATION

Pour enrouler la voile, tirez sur le cordage de manoeuvre en freinant légèrement l'écoute. Si l'enroulement est destiné à la réduction de voilure (et non pas au stockage) avancez le chariot d'écoute au fur et à mesure de la manoeuvre pour assurer un angle de tire adapté à chaque surface de voilure. Pour dérouler la voile, tirez sur une écoute de génou, en freinant le cordage de manoeuvre, pour faciliter le rangement des spires dans le tambour.

To reef or furl the sail, pull the furling line by placing a slight drag on the sheet, in order to prevent the sail from slatting. If the action is aimed to reef the sail (not to furl) move the track traveler forward to insure a good angle of traction on the genoa sheet.

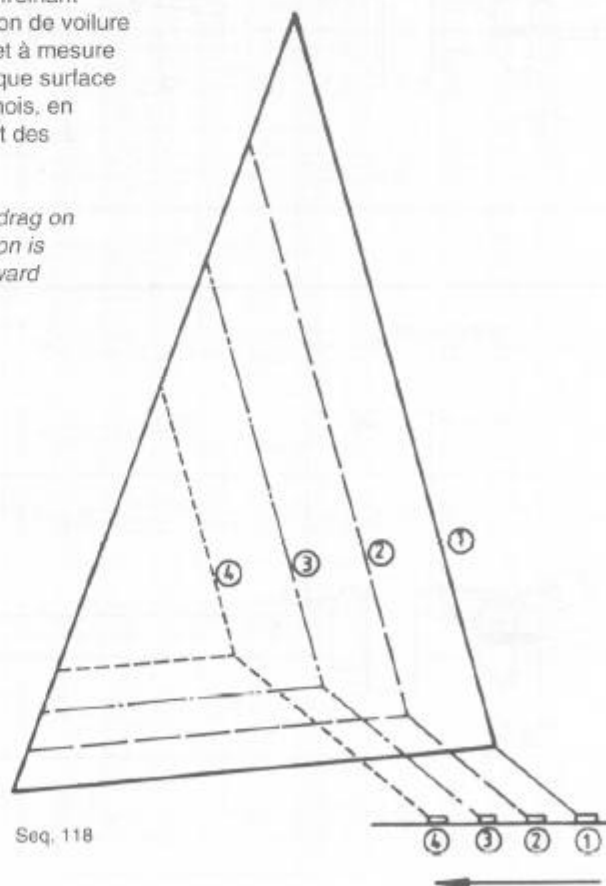

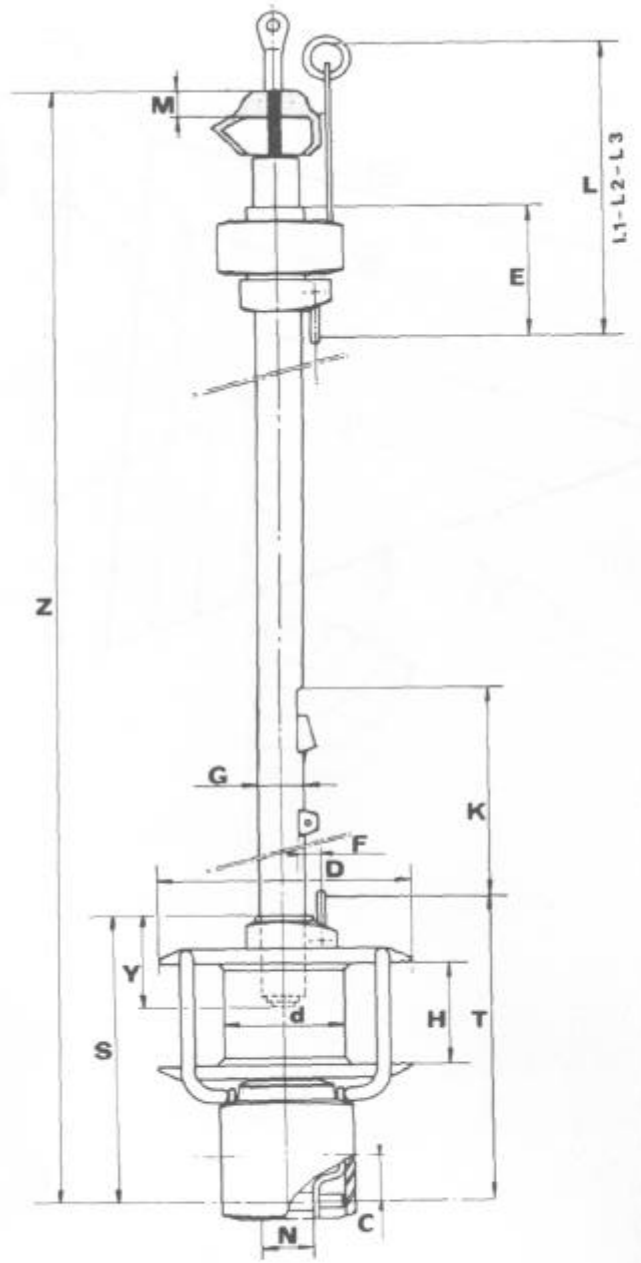

A
Standard

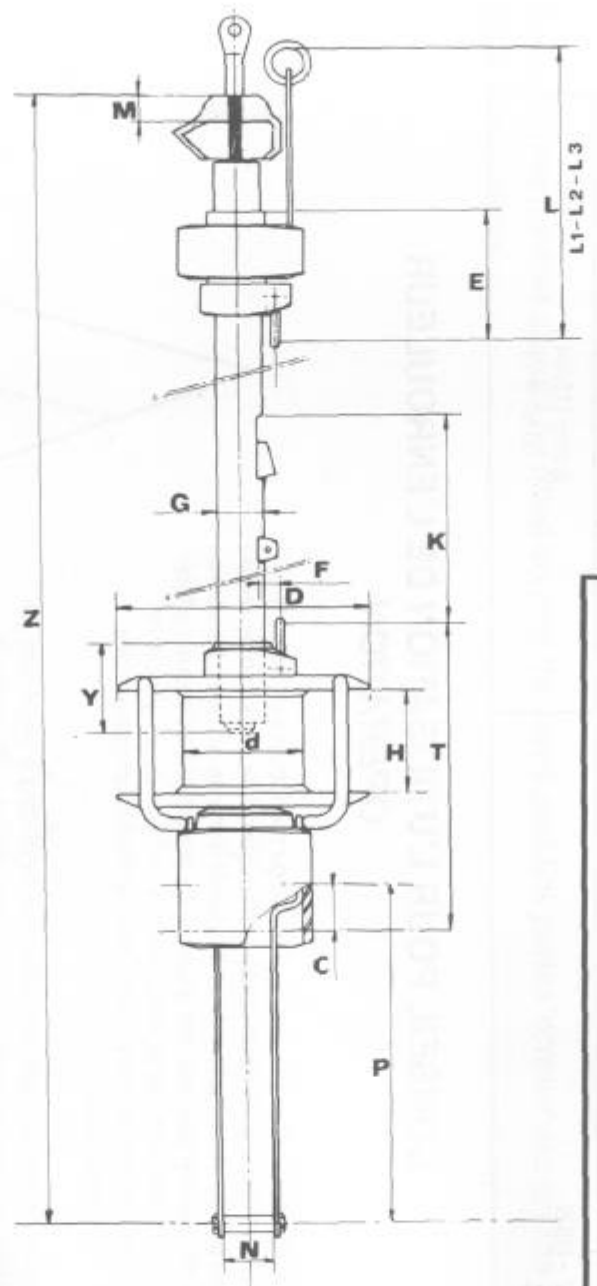

B
Option LL

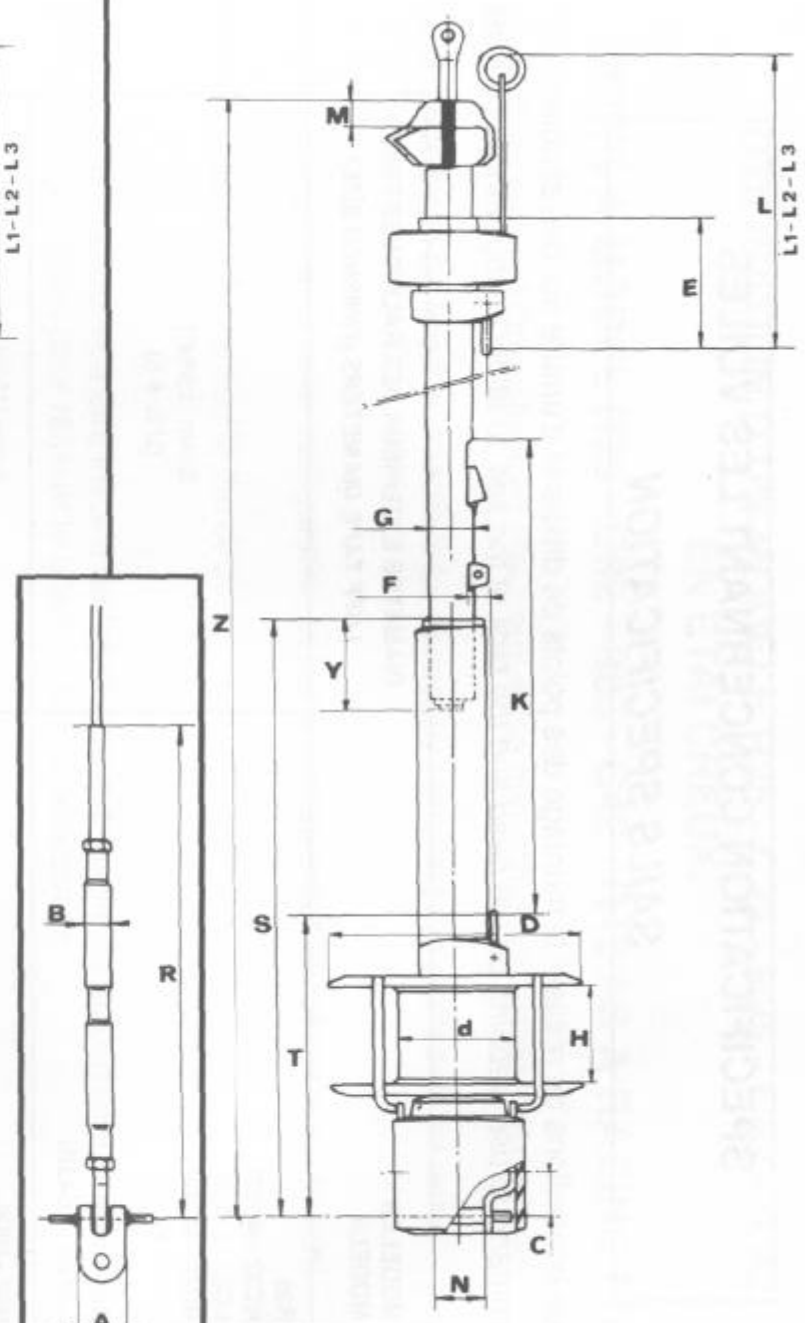

C
Option I

Dimensions (MM)	R 25			NC 32			LC 32			R 35 / R 35E			C 32 / C 32E			NC 42 / NC 42E			Dimensions (MM)
	standard	option LL	option I	standard	option LL	option I	standard	option LL	option I	standard	option LL	option I	standard	option LL	option I	standard	option LL	option I	
	A	B	C	A	B	C	A	B	C	A	B	C	A	B	C	A	B	C	
A max	34	34	34	34	34	34	34	34	34	34	34	34	34	34	34	44	44	44	A max
B max	26	26	26	29	29	29	29	29	29	29	29	29	29	29	29	40	40	40	B max
C	30	30	30	35	-	35	35	-	35	35	-	35	35	-	35	42	42	42	C
D	130	130	130	140	140	140	180	180	180	180	180	180	180	180	180	220	220	220	D
d	76	76	76	72	72	72	72	72	72	92	92	92	92	92	92	105	105	105	d
E	80	80	80	94	94	94	94	94	94	115	115	115	115	115	115	129	129	129	E
F	17	17	17	22	22	22	22	22	22	22	22	22	22	22	22	23	23	23	F
G	25	25	25	32	32	32	32	32	32	35	35	35	32	32	32	42	42	42	G
H	60	60	60	60	60	60	71	71	71	66	66	66	66	66	66	80	80	80	H
K	360	360	610	278	278	570	278	278	570	278	278	540	278	278	540	514	514	825	K
L1	125	125	125	139	139	139	139	139	139	139	139	139	139	139	139	161	161	161	L1
L2	170	170	170	206	206	206	206	206	206	206	206	206	206	206	206	251	251	251	L2
L3	207	207	207	256	256	256	256	256	256	256	256	256	256	256	256	331	331	331	L3
M	18	18	18	22	22	22	22	22	22	22	22	22	22	22	22	28	28	28	M
N	34	34	34	35	35	35	35	35	35	35	35	35	35	35	35	45	45	45	N
P	-	210	-	-	320	-	-	320	-	-	320	-	-	320	-	-	450	-	P
R max	105	290	360	103	423	380	103	423	380	103	415	380	103	415	380	140	590	475	R max
S	160	160	415	180	180	475	180	180	475	165	165	425	165	165	425	220	220	555	S
T	205	205	205	224	224	224	224	224	224	283	283	283	283	283	283	296	296	296	T
Y	72	72	72	77	77	77	77	77	77	70	70	70	70	70	70	80	80	80	Y
Z standard	8130	8310	8380	10150	10470	10450	12150	12470	12450	12150	12470	12410	12150	12470	12410	14200	14650	14540	Z STANDARD
e railing finie finished left tape Ø	5	5	5	5	5	5	5	5	5	5	5	5	5	5	5	5	5	5	e railing finie finished left tape Ø

Dimensions (MM)	LC 42			R 42 / R 42E			C 42 / C 42E			LC 42 R			N 52 / N 52E			L 52 / L 52E			Dimensions (MM)
	standard	option LL	option I	standard	option LL	option I	standard	option LL	option I	standard	option LL	option I	standard	option LL	option I	standard	option LL	option I	
	A	B	C	A	B	C	A	B	C	A	N/A	C	A	B	C	A	B	N/A	
A max	44	44	44	44	44	44	44	44	44	44	-	44	63	63	63	63	63	-	A
B max	40	40	40	40	40	40	40	40	40	40	-	40	49	49	49	49	49	-	B max
C	42	42	42	42	42	42	42	42	42	42	-	42	54	54	54	54	54	-	C
D	220	220	220	220	220	220	220	220	220	220	-	220	250	250	250	250	250	-	D
d	105	105	105	105	105	105	105	105	105	105	-	105	116	116	116	116	116	-	d
E	129	129	129	129	129	129	129	129	129	165	-	165	173	173	173	228	228	-	E
F	23	23	23	20	20	20	23	23	23	20	-	20	25	25	25	25	25	-	F
G	42	42	42	42	42	42	42	42	42	42	-	42	52	52	52	52	52	-	G
H	100	100	100	90	90	90	90	90	90	100	-	100	105	105	105	105	105	-	H
K	514	514	865	514	514	865	514	514	865	510	-	820	620	620	885	620	620	-	K
L1	161	161	161	161	161	161	161	161	161	160	-	160	329	329	329	373	373	-	L1
L2	251	251	251	251	251	251	251	251	251	à/to	-	à/to	429	429	429	473	473	-	L2
L3	331	331	331	331	331	331	331	331	331	310	-	310	529	529	529	573	573	-	L3
M	28	28	28	28	28	28	28	28	28	28	-	28	28	28	28	28	28	-	M
N	45	45	45	45	45	45	45	45	45	45	-	45	65	65	65	65	65	-	N
P	-	450	-	-	450	-	-	450	-	450	-	-	-	680	-	-	680	-	P
R max	160	538	520	130	580	560	130	580	560	220	-	525	200	926	670	220	946	-	R max
S	240	240	575	210	210	560	210	210	560	300	-	605	315	315	780	335	335	-	S
T	316	316	316	316	316	316	316	316	316	330	-	330	396	396	396	441	441	-	T
Y	72	72	72	80	80	80	80	80	80	80	-	80	112	112	112	112	112	-	Y
Z standard	16220	16628	16540	14190	14640	14540	16190	16640	16540	16280	-	16590	16260	16940	16730	18280	18960	-	Z standard
e railing finie finished left tape Ø	5	5	5	5	5	5	5	5	5	5	-	5	6	6	6	6	6	-	e railing finie finished left tape Ø

TABLEAU DE PANNES

OPERATION TROUBLES

DEFAUT CONSTATE <i>PROBLEM</i>	CAUSE <i>CAUSE</i>	REMEDES : "voir Seq. N°" <i>REMEDIES : "see Seq. N°"</i>
L'enrouleur ne tourne pas. <i>System not rotating.</i>	Emérillon mal réglé. <i>Halyard swivel badly adjusted.</i>	Seq.106 - 109
L'enrouleur tourne avec difficulté. <i>System hard to turn.</i>	Poulies de renvoi sous dimensionnées. <i>Furling blocks too small.</i>	Installer poulies plus grosses. <i>Install larger blocks.</i>
Le cordage de manoeuvre sort du tambour. <i>Furling line jamming out of the drum.</i>	1ere poulie de renvoi mal placée. <i>First furling block badly tuned.</i>	Seq. 101
	Cordage de manoeuvre trop gros. <i>Furling line is too big.</i>	Changer Ø cordage. <i>Change line diameter.</i>
	Tambour surchargé. <i>Overfilled drum.</i>	Rouler la voile serrée et enlever les tours inutiles. <i>Furl sail tight and remove remaining coils.</i>
	Trajet du cordage incorrect. <i>Bad arrangement of furling line.</i>	Seq.101 - 103

ENTRETIEN

MAINTENANCE

Votre enrouleur a été conçu pour fonctionner sans entretien durant de nombreuses années. Cependant, pour lui conserver un aspect neuf, il est recommandé de procéder au moins une fois par an à un rinçage à l'eau claire des parties mécaniques, et à un nettoyage des gaines avec un chiffon imbibé d'alcool.

Your PROFURL requires no special maintenance, but to keep it clean and looking new you can rinse it with fresh water to remove salt or dirt from the components.

www.profurl.com

WICHARD France

Hotline / Support technique / SAV
33 rue de l'Etoile du matin
44600 Saint Nazaire,
France
Tel +33 (0)2 51 76 00 35
Fax +33 (0)2 40 01 40 43
Email : hotline@wichard.com

WICHARD, Inc

148a Bryce Blvd
Fairfax - VT05454
USA
Tel : +1 401 683 5055
Fax :+1 802 655 4689
Free toll number: + 1 800 852-7084
Email : info@wichard-usa.com

WICHARD PACIFIC Pty Ltd

Unit 13, 2 Bishop Street
St Peters NSW 2044,
Australia
Tel : + 61 2 9516 0677
Fax : + 61 2 9516 0688
Freecall from Australia: 1800 639 767
Email : info@wichard.com.au