

MXL Membranes

MXL

ADVANCED LOADPATH SAILS Club Race LP Membrane Sails

The all Aramid Advanced Load Path Membrane for Club Race application - sails under 45 square meters. MXL Club incorporates all of the technology developed for our advance load path sails but is uniform with an all aramid fiber content. These sails are super smooth with advanced resistance to stretch for shape stability.



MXL

ADVANCED LOADPATH SAILS Multi Panel Membrane Sails

This range of membranes is available for sails up to 45 square meters but incorporates all the options available in our Wide Panel membranes. The Multi-Panel sails can include a wide range of fiber content including Carbon and Technora. These sails are available with taffeta, single layer, double sided or internal core.



MXL

ADVANCED LOADPATH SAILS Wide Panel Membrane Sails

The MXL Wide Panel sails are truly custom, available in any panel width and fibers combined with taffeta availability. These membranes can incorporate custom load path layouts as specified by the sailmaker and are our most technically advanced membrane



Various Stages of Finishing Can Be Ordered.

Wide Panel and Multi Panel MXL Membrane sails are available as:

1. "Finished Sail" Ready to hoist with four week delivery
2. "Membrane Only" A complete skin, seamed and patched with delivery in three weeks
3. "Fast Panels" Cut panels with availability in 2 weeks

Deliveries quoted are subject to demand.

MXL Membranes

MXL Surface Types

MXL Surface Styles

MXL Wide and Multi panel membrane sails are available in four different surface types allowing sailmakers to offer the most suitable membrane sail to their customers.

MXL - GP: film/film

Film to film sails:

Top of the line race sails in a film/ film configuration. MXL GP Race is available for modern skiffs right up to the maxi racer. Flexible choice of hi-tech fibres and scrim to get your own look and specification. Film thickness varies between 1 and 3 mil (12 – 36 micron) depending on sail size.

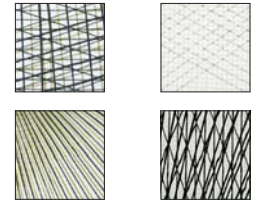

MXL - 1T : single taffetas

Film surface on one side and Taffeta on the other:

The single taffeta is the ideal choice for the cruiser racer. The Taffeta adds durability and longevity whilst still with a great hi tech look. The standard 75 gram taffeta can be upgraded to a Gossamer light 40 gram.



MXL - 2T : double taffeta

Taffeta on both sides of the sail:

MXL double taffeta is the ultimate cruising product for the knowledgeable cruiser. The sail is protected by a rugged taffeta exterior in white or light grey with other colours available on request.



MXL - TC : taffeta core

A film/film load path membrane sail with a 40gsm taffeta sandwiched between the external film and Fibre layers giving a softer hand and increased durability over typical film/film only sails. Available with a grey or white taffeta. Grey taffeta is suggested for black (Carbon and Technora) fibre, or black / Kevlar mix fibre sails, and white taffeta for Polyester / Pentex or Vectran fibre sails.

MXL Fibre, Taffeta and Scrim

Large Variety of Fibres Available

- | | | | |
|--------------------|---|----------------------|---|
| • Polyester | | • Technora / Aramid | 4 |
| • Pentex | 1 | • Vectran / Technora | 5 |
| • Aramid (Gold) | 2 | • Carbon / Aramid | 6 |
| • Technora (Black) | 3 | • Carbon / Technora | |
| • Vectran | | • Carbon / Vectran | |
| | | • Carbon | |

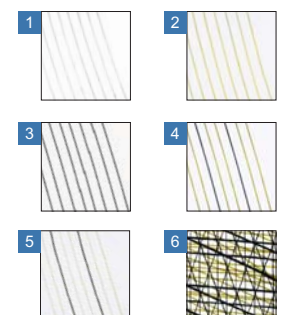

Scrim, film, taffeta options

- | | |
|---|---|
| • Upgrade polyester scrim to Technora X Ply Scrim | • Upgrade to 40 gsm gossamer light taffeta |
| • Downgrade Technora X-Ply scrim to Polyester | • Change to Grey Taffeta - no charge |
| • Upgrade to 100% UV film (clear only) | • Any colour to special order - ask for quote |
| • Upgrade from clear to Grey tinted film | |

Warranty

MXL Sails are guaranteed for 12 months against faulty workmanship - subject only to proper maintenance and being used in appropriate wind conditions.

MXL Mainsail Membranes

Standard

MXL
ADVANCED LOADPATH SAILS Custom Membrane Sails

Standard Features of MXL Mainsails:

- Top Full Batten - Balance short
- Tapered Vinylester battens
- Cunningham
- Strung laminated corner patches
- Alloy headboard
- Rutgerson Super rings in reefs (carbon SR rings with carbon sails)
- Drawstring carry bag
- Spectra webbing reinforcements
- Vectran leech lines
- Draft Stripes and Tell Tales
- Supplied loose spreader patches
- Bolt rope or standard slides
- Ultrabonded Seams reinforced with sewing on Taffeta faced surfaces

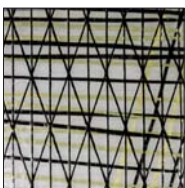
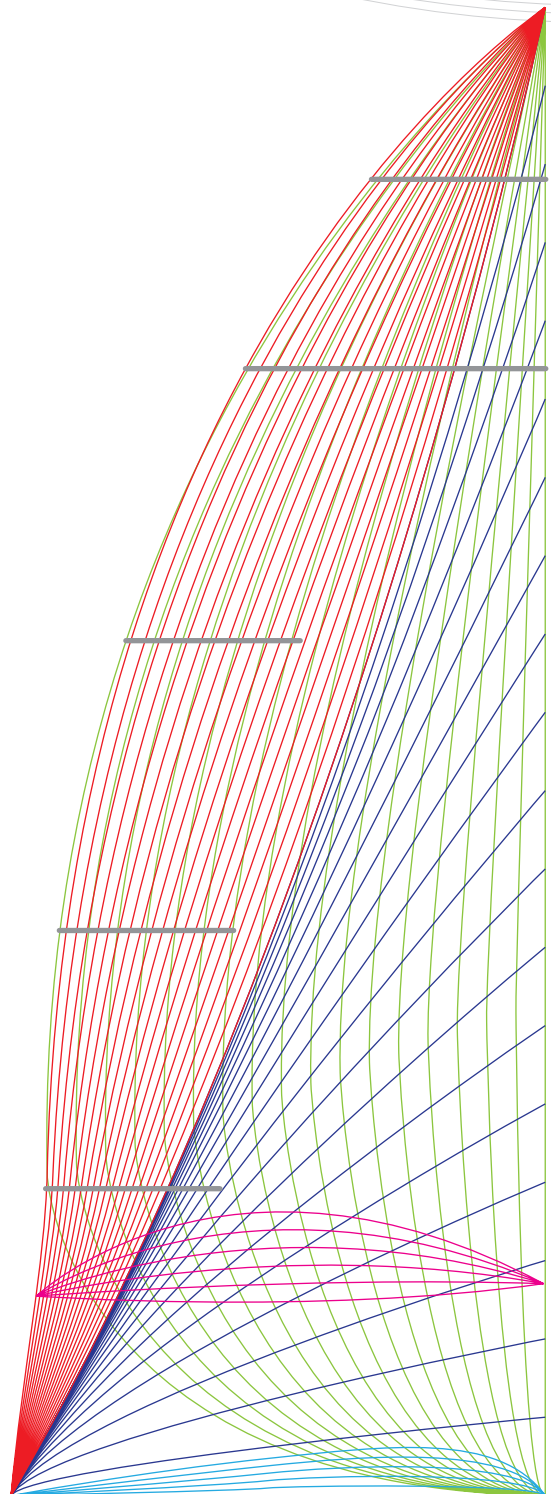

Fibre Close up



Strung Patch



Reef at Luff



Luff Box and
Roller Slide



Leech Batten End



Headboard Detail

MXL Headsail Membranes

Standard

MXL
ADVANCED LOADPATH SAILS Custom Membrane Sails

Standard Features of MXL Headsails:

- Strung laminated corner patches
- Stainless O Ring or Spectra webbing at corners
- Drawstring carry bag
- Spectra webbing reinforcements
- Vectran leech lines
- Draft Stripes and Tell Tales
- Tell Tales window
- Luff tape or brass hanks
- Supplied loose spreader patches
- Top Full Batten
- Ultrabonded Seams reinforced with sewing on Taffeta faced surfaces

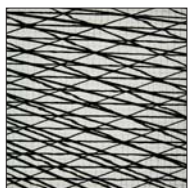
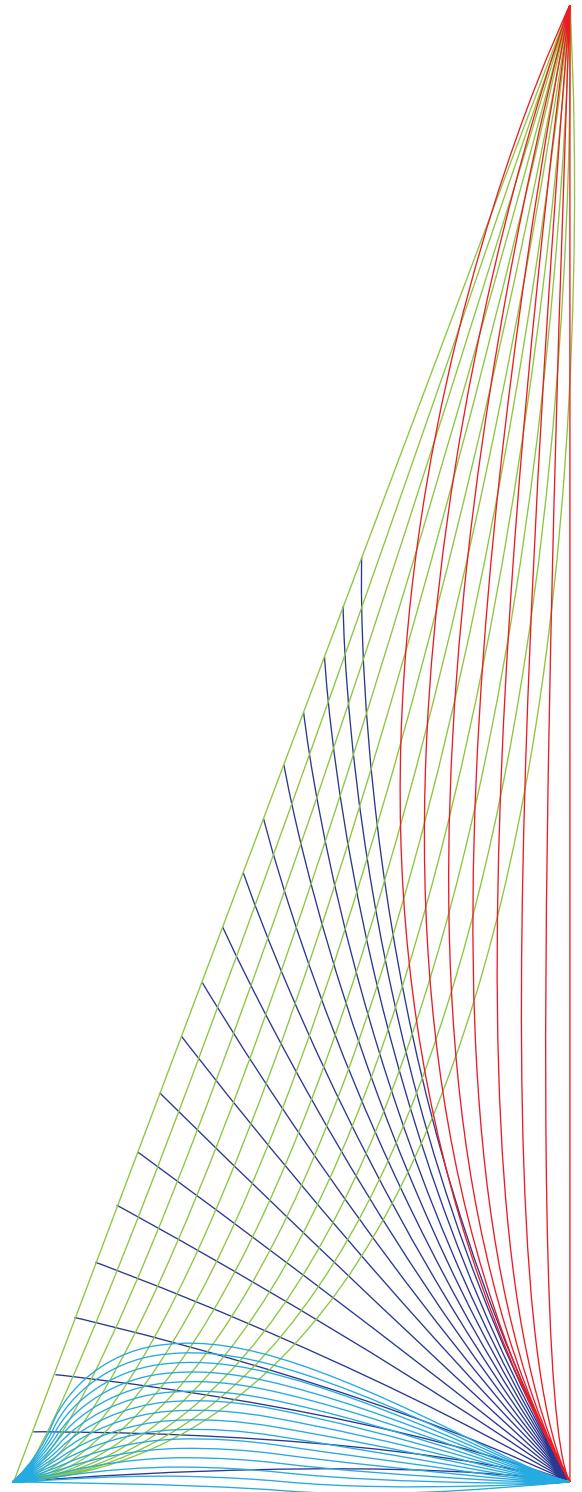

Fibre Close up



Strung Patch



Clew Finishing



Head Finishing



Tack Finishing

MXL Club - Race LP membranes in Club Black and Club Gold

Standard

An all Aramid Membrane Sail for less than a Tri-Radial Laminate

This derivative of our proven MXL narrow panel sails combines Membrane Technology with all Aramid Load Path Fibers at very competitive prices. MXL Club Race LP features warp inserted aramid fiber to support the sail from leech to luff, with strung aramid load path fibers to address leech and luff loading. A rugged 22° scrim is also incorporated to create a very durable membrane. These membrane also feature a unique vertical head layout which distributes loading more effectively than a narrow panel crosscut seam.

Drawing guide:

- 1 Film
- 2 Load path strung aramid
- 3 Inlaid warp aramid
- 4 Rugged 22° X Scrim
- 5 Film

- Competitively priced and with proven technology, our Club-Race LP sails are ideally suited for the Club Racing market.
- Club-Race LP sails are available from 8m² up to 45m² with four weeks delivery; The price includes a Load Path layout specifically tailored to your sail design.

Club Race LP is available in black or gold.

- Black fibre is Technora
- Gold fibre is Kevlar

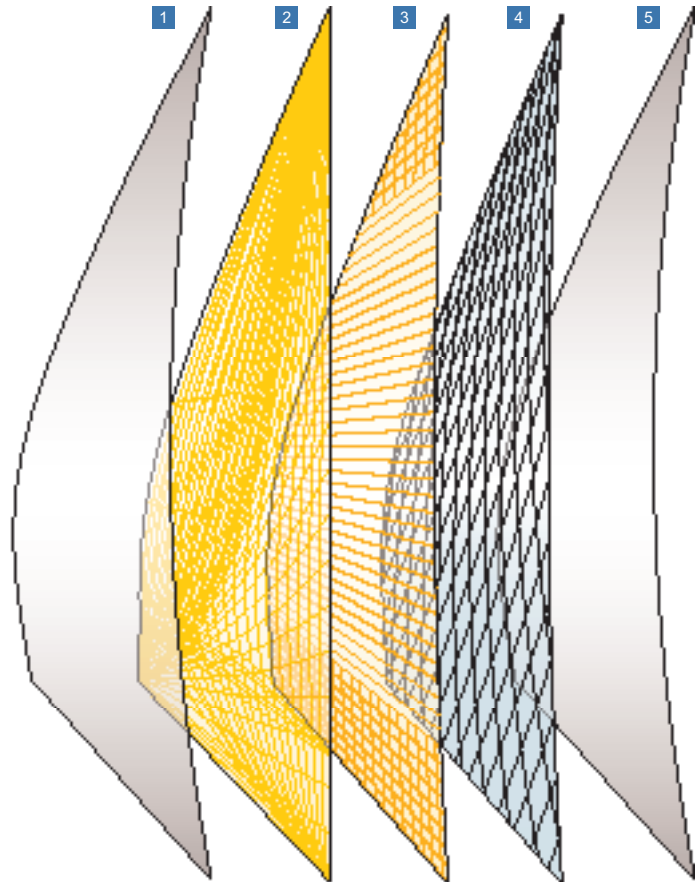

Prices

Great Prices - a film film membrane sail with Aramid load path yarns for not much more than a good quality woven Dacron sail.



Custom Axis Laminate Sails

Cruising version in double taffetas - Cruise-Race version in film/film

Performance sails for the price of dacron

Custom Axis Laminate Sails is our version of a membrane sail that incorporates multi directional fiber to address the loads in a modern cruising and Club Race application. The Custom Axis Laminate places the fiber in efficient directions, customized for each sail, to maintain durable shape retention efficiently

Custom Axis Laminate sails are now offered in both a traditional double taffeta Cruising version and a film on film version for high value Club Race applications.

The sail is an asymmetric, multi axial laminated sail with crosscut panels parallel to the foot. Strung primary fibres for leech loads decrease in density towards the luff whilst secondary fibres are strung to address clew to luff loads.

This unique construction method gives Custom Axis Laminate sails their highest strength in the load line where it is needed and eliminates the dead weight of additional fibres running in unloaded directions necessarily present in normal sailcloth.

Yet they are available at the price of a good Dacron sail. Long term performance, on the other hand, is greatly superior to that of a Dacron sail



Custom Axis Laminates - Build Features

The aspect ratio of your design will determine the primary and secondary load directions and from this CSF will create the fibre load path design.

The two load line fibres are custom strung each in straight parallel lines across the sail panel. Fibre density is greatest at the leech and decreases across the panel towards the luff providing the appropriate amount of denier in each part of the sail.

The bottom two or three panels (depending on sail size – see sail maker's instructions on page 39) have a vertical seam. The forward panel will have both primary and secondary fibres strung in symmetrically reverse directions to address tack loads.

The top panel is vertical and up to 2800 mm deep to provide continuous fibre to meet the increased loads in the head. Depending on sail size this vertical panel may be split into two.

The Cruising version has a woven 75 g/m² Polyester Taffeta is laminated to both sides of the sail. A gossamer light 40 gsm Taffeta is available as an optional extra. The Taffeta is laminated with an anti-fungicide additive for mildew and mould protection.

The Cruise-Race Version is film/film using 23 micron film giving 2 mil total film weight.

A Polyester ripstop scrim is laminated in the membrane.

We specify Pentex[®] or Vectran[®] fibres for the Cruising Version as both fibres have excellent flex resistance suitable for cruising sails. Pentex has 2½ times the stretch resistance of ordinary polyester, whilst Vectran exceeds Kevlar in stretch resistance but does not suffer from “creep”, a slow and permanent elongation of the fibre over time, commonly associated with Spectra and Dyneema.

For the Cruise-Race version we specify Pentex[®] or Black Technora[®] fibres. The Black Technora aramid has excellent stretch and UV resistant and is good in flex compared to Kevlar.

UV protection is addressed using our industry first 100% UV block film, which is an optional extra., Although greater in gauge, this is the exact same film as is laminated to glass used in cars and buildings to prevent UV fading damage to interior furnishings. This film will block all damaging UV and is guaranteed for fifty years and whilst considerably more costly than conventional mylar films, greatly enhances fibre longevity and the sustained performance of Custom Axis Laminate Sails.

Patches are designed by CSF to be oversized with the outermost patch custom strung with radial fibres.

Custom Axis Laminate (CAL) Mainsails

We produce MXL Custom Axis Laminate Cross cut mainsails in several formats:

- A Battened Mainsail; full, partial or short
- In mast Roller Furling with a hollow leech and clew block
- In mast Roller Furling with a positive roach supported by Vertical battens and with a clew block
- In boom Roller Furling with full battens (for example: Leisurefurl, Pro-furl, Shaefer, etc)

As you would expect our Custom Axis Laminate Mainsails are produced with comprehensive standard features which are detailed here together with options.

Standard

Standard specifications for Custom Axis Laminate Mainsails

- 1 full top batten pocket and 3 short pockets up to 35m² and 2 full top batten pockets and 4 short pockets over 35m²
- Appropriate slides and luff boxes
- Vectran[®] or Pentex[®] in the cruising version and Pentex[®] or Black Technora in the Cruise-Race version fibre
- Leech lines with clam cleats
- Foot lines
- Press ring (or O ring) at clew and webbing loop at tack and head
- Draft Stripes
- Tell Tales
- Laminated and sewn radial patches

Options

Options available for Custom Axis Laminate Mainsails

- 100% UV block Film in lieu of standard Mylar
- All Cross Cut mainsail options shown on page 4 are available including Blue Water finishing.

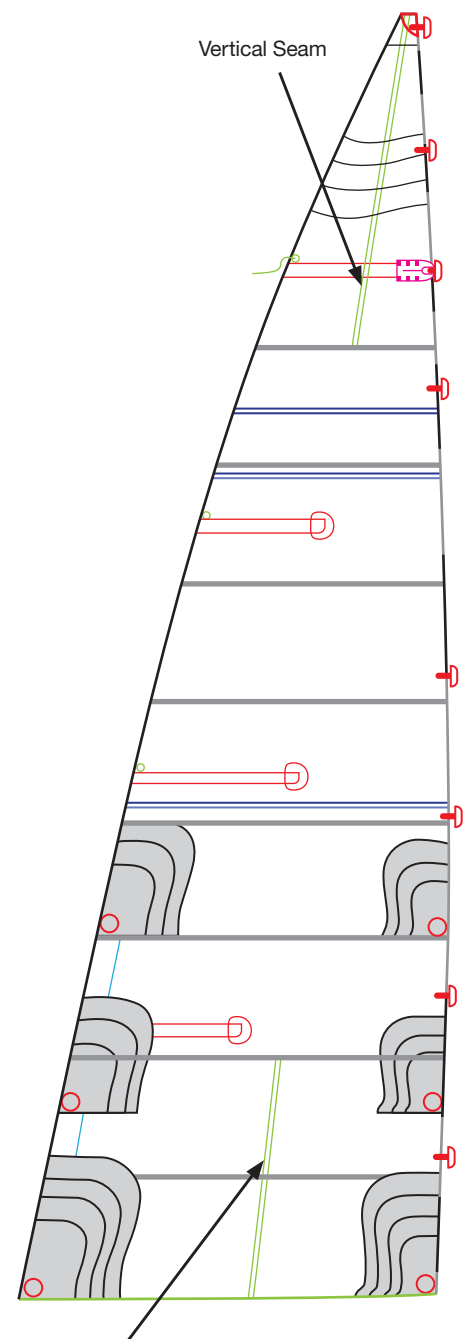
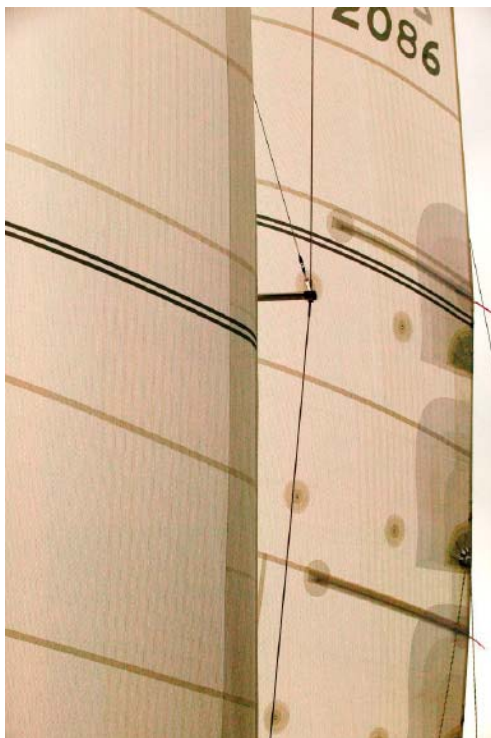

Bottom two panels divided by vertical seam

Custom Axis Laminate (CAL) Headsails

We produce MXL Custom Axis Laminate Cross cut headsails in two formats:

- a) A jib with an LP of less than 105%
- b) A Genoa with an LP of 105% or higher

Furling with luff tape and non furling with luff tape or hanks.

As you would expect our Custom Axis Laminate headsails are produced with comprehensive standard features which are detailed here together with options.

Standard

Standard specifications for Custom Axis Laminate Headsails

- Selectable webbed ring, press ring or webbing loop at head with roller furling headsails fitted with a leather reinforced webbing loop for UV protection.
- Selectable webbed ring, press ring or webbing loop at clew and tack
- Appropriate luff tape or hanks
- Vectran® or Pentex® fibre in the cruising version and Pentex® or Black Technora in the Crusie-Race version
- Leech and foot lines with clam cleats (in vectran over 35m²)
- Draft or furling Stripes
- Tell Tales Port and Starboard
- Laminated and sewn radial patches
- Short batten pockets suitable for tapered battens

Options

Options available for Custom Axis Laminate headsails

- 100% UV block Film in lieu of standard Mylar
- All Cross Cut headsail options shown on page 6 are available including Blue Water finishing.

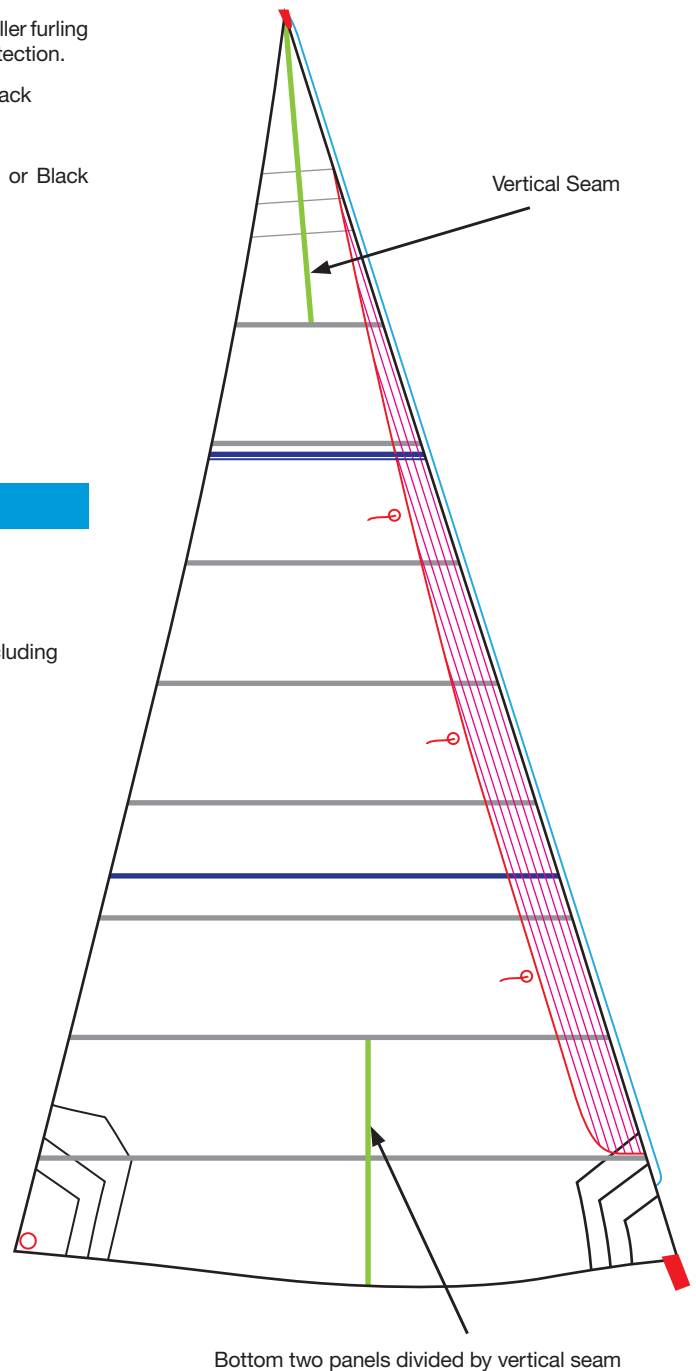
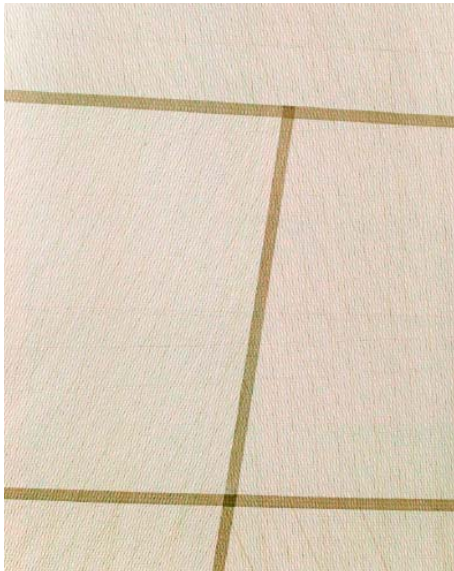

Bottom two panels divided by vertical seam