

CONTENTS

GENERAL INTRODUCTION TO B&G NETWORK	2
INTRODUCTION TO NETWORK QUAD	3
EXAMPLE SYSTEMS USING NETWORK QUAD	4
SELECTING THE DISPLAY MODE	5
USING THE SPEED KEY	6
CALIBRATION AND OPERATING PARAMETERS	7
SETTING THE DISPLAY DAMPING	8
SETTING THE SPEED AND LOG UNITS	9
SPEED AND LOG CALIBRATION	10
1 - MANUAL CALIBRATION - CAL	11
2 - MANUAL CALIBRATION - LOG CAL.....	12
3 - AUTOMATIC CALIBRATION - AUTO CAL.....	13
RESETTING THE DEAD RECKONED DISTANCE	15
USING THE DEPTH KEY	16
THE DEPTH DATUM - CAL	17
SETTING THE DEPTH DATUM	18
SETTING THE DEPTH UNITS	19
DEPTH ALARMS	20
SHALLOW ALARM	
ENABLING/DISABLING THE SHALLOW ALARM	21
ADJUSTING THE SHALLOW ALARM VALUE	21

DEEP ALARM	
ENABLING/DISABLING THE DEEP ALARM	22
ADJUSTING THE DEEP ALARM VALUE	22
ANCHOR ALARM	
USING THE ANCHOR ALARM	23
ENABLING/DISABLING THE ANCHOR ALARM	24
ADJUSTING THE ANCHOR ALARM SHALLOW LIMIT	25
ADJUSTING THE ANCHOR ALARM DEEP LIMIT	25
USING THE TIMER/TEMP KEY	26
RESETTING THE TRIP LOG	27
SETTING THE TIMERS AND LAP TIMER	28
SETTING THE TEMPERATURE UNITS	29
CALIBRATING THE TEMPERATURE SENSOR	30
USING THE LIGHTS KEY	31
NETWORK ALARMS	32
FAULT AND ERROR MESSAGES	33
INSTALLATION	34
SITING THE UNIT	34
MOUNTING THE UNIT	34
SPECIFICATION	36

GENERAL INTRODUCTION TO B&G NETWORK

The B&G Network range of instruments is designed to be used as individual units or connected together to form an integrated navigational system. A single network cable is used to carry data and power between units. The latest technology and screened cables throughout the Network System ensure the ultimate protection from interference between units and other systems. All Network instruments can be linked to Network PILOT, Network CHART, Network GPS or Network LORAN receivers or via NMEA 0183 (v1.5) to other navigational equipment.

INSTRUMENTS

- Network SPEED
- Network DEPTH
- Network QUAD
- Network WIND
- Network TACK
- Network DATA

NAVIGATIONAL AIDS

- Network NAV
- Network GPS
- Network LORAN
- LCD CHART

AUTOPILOTS

- Network PILOT

INTRODUCTION TO NETWORK QUAD

The Network QUAD unit measures and displays Speed, Depth, Log, Timer and Sea Temperature information on a large back-lit Liquid Crystal Display (LCD). The LCD is divided into three display areas. The top area permanently shows speed information, the centre area is selectable and shows Log, timer, sea temperature and depth alarm information, and the bottom area permanently shows depth information.

The five keys allow selection of the displayed information and setting of the units mode, calibration factors and operating parameters.

It can operate as the main Network QUAD unit either alone or as part of an Integrated Network Instrument System taking inputs directly from Speed and Depth Sensors which plug into the sockets at the rear of the display, or as a repeater (by selecting repeater mode) of information received via the two Network cable tails.

The Network QUAD REPEATER (not a Network QUAD in repeater mode) does not have Speed and Depth Sensor sockets, so it only receives data via the system network. It offers identical facilities to a Network QUAD main unit but can only ever be used as a repeater.

INTRODUCTION TO NETWORK QUAD CONT'D

The Network QUAD unit has three adjustable alarms:

1. Shallow water alarm
2. Deep water alarm
3. Anchor alarm

An internal alarm buzzer will sound when an alarm condition is met and the display will flash. The alarm is broadcast to all other Network Instruments in an integrated system, they will also sound their alarms and flash their displays (except Network WIND and Network TACK).

The Network QUAD unit is NOT able to transmit NMEA 0183 (v1.5), however, the Network QUAD REPEATER unit is able to transmit NMEA data via the system network cables to other Network units and connect to an NMEA device e.g. a position fixer, with a special NMEA output cable.

IMPORTANT NOTE

Your Network QUAD unit must be set-up and calibrated correctly before it is used as part of a navigational system.

NETWORK QUAD DISPLAY UNIT

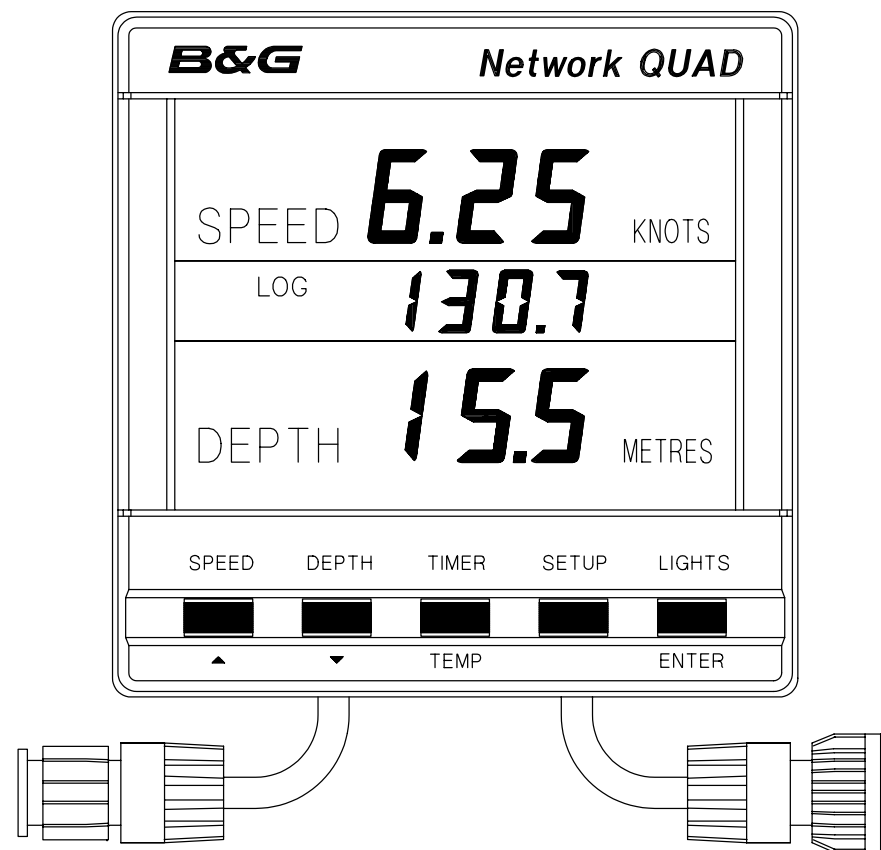

EXAMPLES SYSTEMS USING NETWORK QUAD

Only one Network QUAD unit should have speed and depth sensors connected to it and set to transducer mode. Up to three more Network QUAD (set to repeater mode) or QUAD REPEATER units can be connected on to the system network.

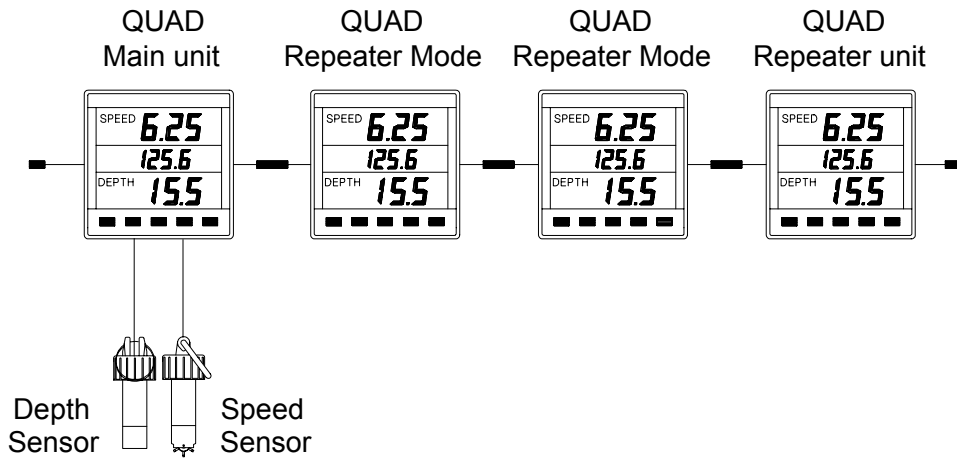

When in repeater mode, if the data is not being received from the system network, the display will show OFF when a key is pressed.

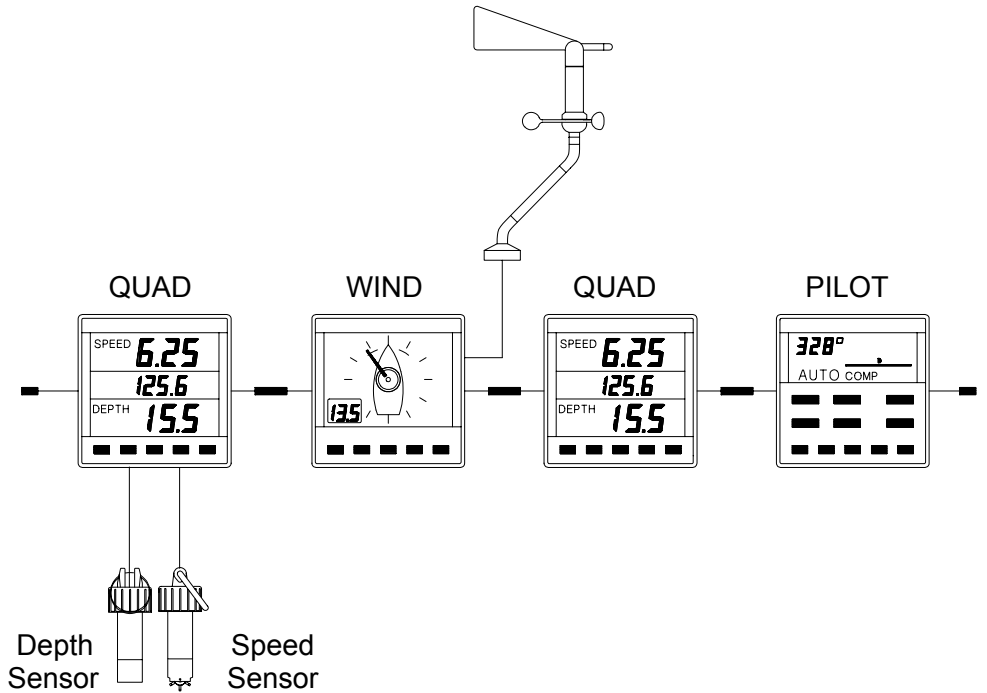
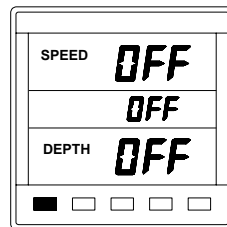

If the Network QUAD unit losses valid depth data, due either the actual depth being outside the working range, or to extreme turbulence in the water the LCD will show 3 "floating" bars. This shows that the unit is attempting to calculate the depth and is still functioning.

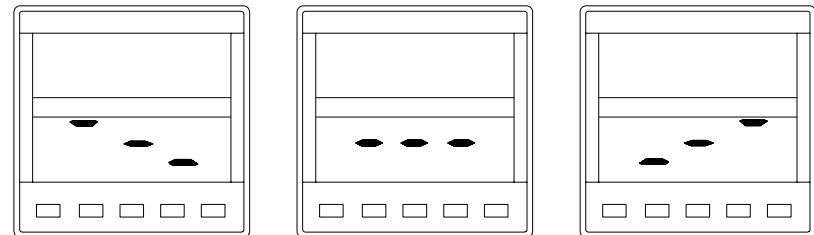

SELECTING THE DISPLAY MODE

The Network QUAD unit has two operating modes. The correct mode must be selected for your Network system to operate properly.

tYPEt Transducer mode, the unit uses and displays speed and depth data from sensors connected directly into the display unit.

tYPEr Repeater mode, the unit operates as a repeater using data from the system network.

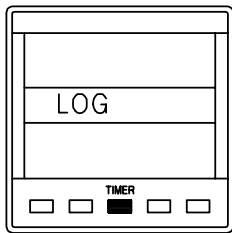

Press **TIMER** key to display stored log.

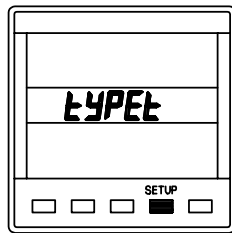

Press **SETUP** key to display the current mode.

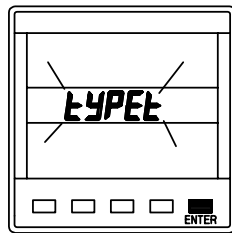

Press **ENTER** key if the mode needs to be changed.

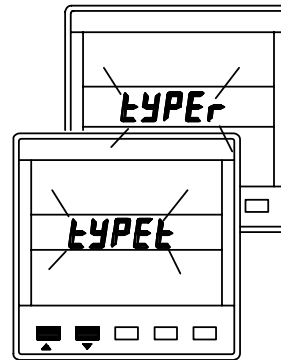

Use ▲ or ▼ to change mode.

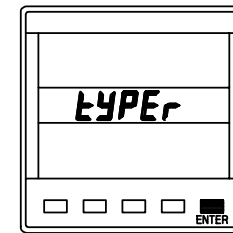

Press **ENTER** to store the new mode in memory.

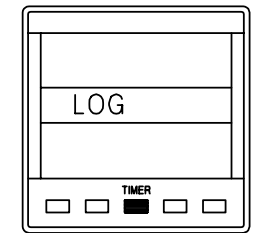

Press **TIMER** to complete the change.

USING THE SPEED KEY

Boat speed information is permanently displayed in the top area of the LCD.

Press the **SPEED** key to cycle through the following options:

- SPEED** Current boat speed in Knots, can also be displayed in MPH.
- AVERAGE SPEED** Average boat speed since the last reset of the trip log.
- MAX SPEED** Maximum boat speed since the last reset of the trip log.

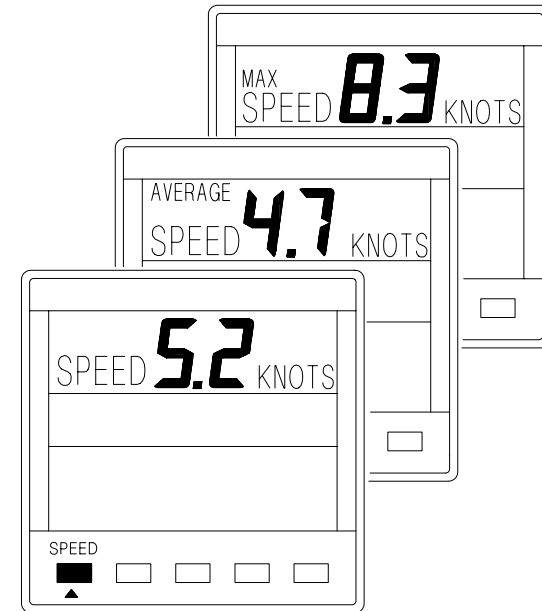

CALIBRATION AND OPERATING PARAMETERS

When current boat speed is displayed, press the **SETUP** key to cycle through the following options:

- DAMPING** The response time of the display to changes in boat speed.
- SPEED**
KNOT The boat speed can be displayed in Knots or MPH. This setting also changes the log units to Nautical or Statute Miles.
- CAL** Manual boat speed and log calibration.
- LOG**
CAL Manual boat speed and log calibration.
- AUTO CAL** Automatic boat speed and log calibration.
- dr** Reset Dead Reckoned Distance.

When in **SETUP** mode:

- The **SPEED** key becomes the UP key ▲
- The **LOG** key becomes the DOWN key ▼
- The **LIGHTS** key becomes the **ENTER** key

The procedures for using the SETUP options are on the following pages.

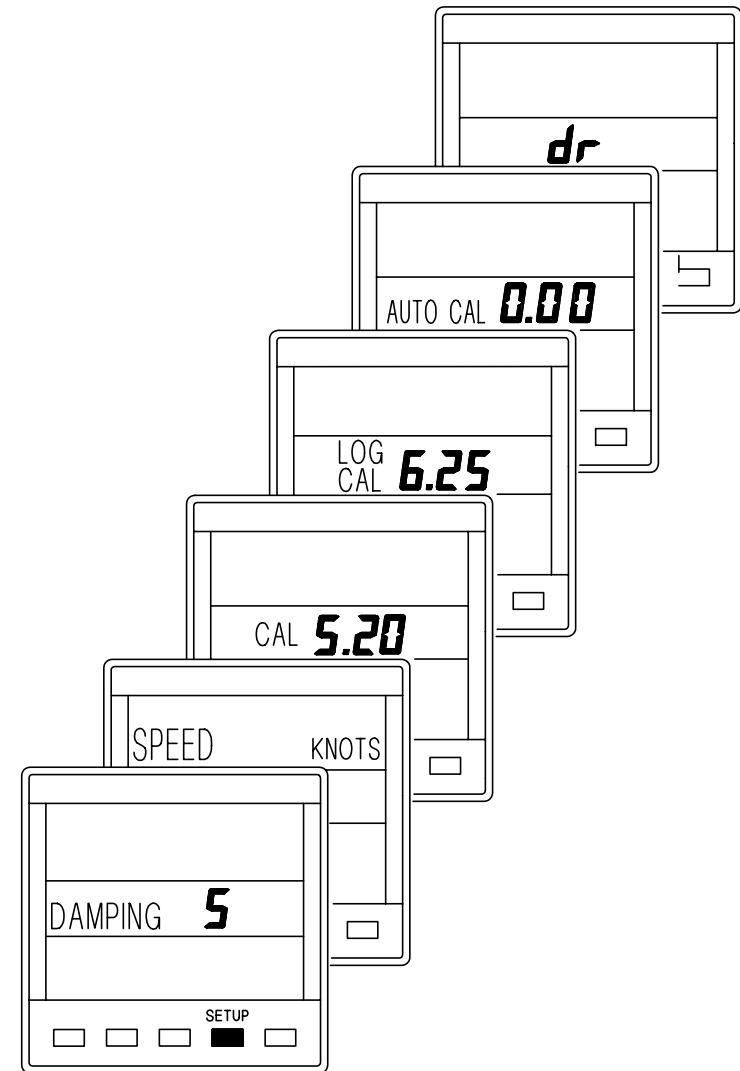

SETTING THE DISPLAY DAMPING

Damping allows the response time of the displayed speed value to be slowed down if it is to jumpy in rough weather, or to sped it up when the conditions are calm. The damping works by averaging the values over a set time period; the longer the time period the smoother the readings, however the longer it takes to see a change. Similarly the shorter it is the jumpier the readings, but the faster the response.

The Network QUAD unit has a factory set value of 5, this can be adjusted in the range 1 to 64, each step is approximately one second.

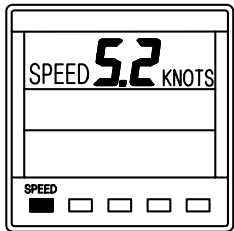

Press **SPEED** key to display current boat speed.

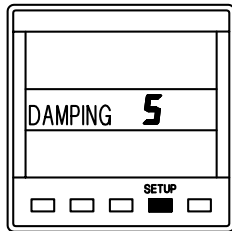

Press **SETUP** key once to display the damping value.

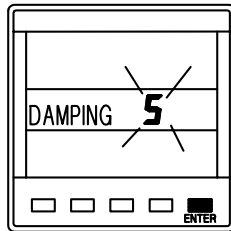

Press **ENTER** key if the value is to be changed.

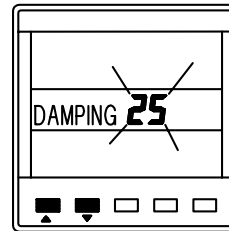

Use ▲ or ▼ to change the value.

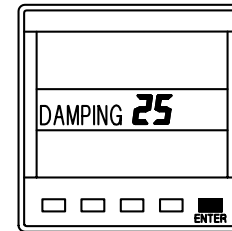

Press **ENTER** key to memorise the change.

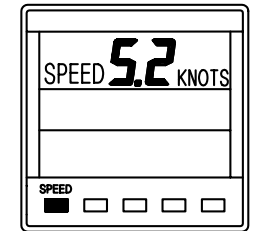

Press **SPEED** key to display current boat speed.

SETTING THE SPEED AND LOG UNITS

The Network QUAD can be set to display boat speed in Knots or MPH.

If boat speed is in Knots then log is in Nautical Miles.
If boat speed is in MPH then log is in Statute Miles.

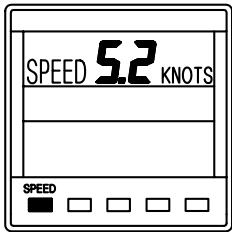

Press **SPEED** key to display current boat speed.

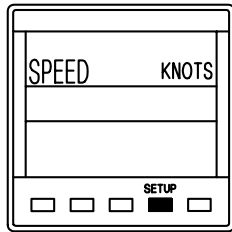

Press **SETUP** key twice. The speed digits will blank.

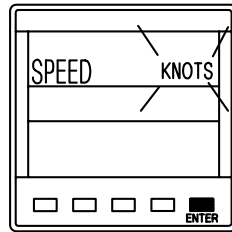

Press **ENTER** key if the units are to be changed.

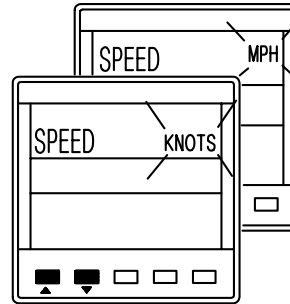

Use ▲ or ▼ to change the units.

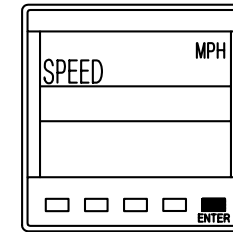

Press **ENTER** key to memorise the change.

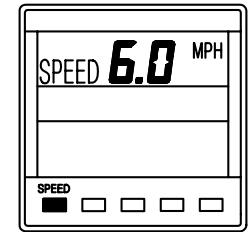

Press **SPEED** key to display current boat speed.

SPEED AND LOG CALIBRATION

Before Network QUAD is used for navigation the boat speed and log have to be calibrated to ensure accuracy for your installation and the boats hull characteristics.

Three methods are available with the Network QUAD unit, two manual adjustments and one automatic:

MANUAL CALIBRATION

1. **CAL** The displayed boat speed value is corrected manually to read a known measured speed.
2. **LOG CAL** The units calibration figure (Hz/Knot) is manually adjusted to correct log and speed inaccuracy.

AUTOMATIC CALIBRATION

3. **AUTO CAL** The unit automatically calibrates and corrects the boat speed and log.

Use the one of the methods overleaf to calibrate your instrument. It is recommended that **AUTO CAL** is used as this method will ensure the most accurate calibration of your Network QUAD unit.

METHOD 1. - MANUAL CALIBRATION - CAL

This procedure requires a reference boat speed with which to compare the Network QUAD units displayed boat speed. For example, another boat with an accurate calibrated log, or if the top speed of the boat is known this value can be entered during a sea trial to correct the displayed value.

NOTE: The accuracy of this method is dependent upon the accuracy of the reference boat speed.

The example below shows a displayed boat speed of 5.2 knots, the boat speed is known to be 6.0 knots. The displayed value is adjusted to read 6.0 knots.

IMPORTANT NOTE: This method of calibration must not be carried out at boat speeds of LESS THAN 3 KNOTS as inaccurate values can be entered into the units memory. If the speed and log are not functioning correctly then enter a calibration value of 5.3 to 6.2 and then re-enter the correct calibration value as described below.

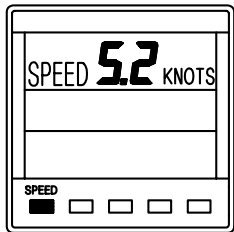

Press **SPEED** key to display current boat speed.



Press **SETUP** key three times to display **CAL**.

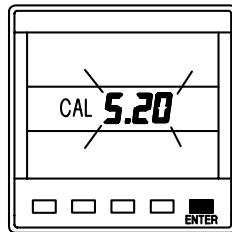

Press **ENTER** key to adjust the displayed value.

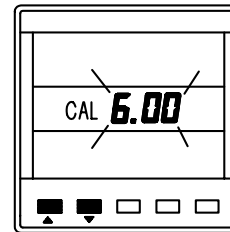

Use **▲** or **▼** to change the value.

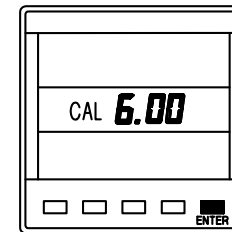

Press **ENTER** to store the new value in memory.

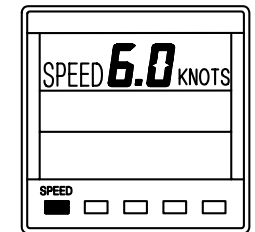

Press **SPEED** key to complete the change.

METHOD 2. - MANUAL CALIBRATION - LOG CAL

If the log or boat speed is in error by a known percentage then this method allows the calibration figure or **LOG CAL** to be adjusted by that amount. The calibration figure is measured in Hertz per knot (Hz/kt), the factory set value is 6.25.

NOTE: The accuracy of this method is dependant upon the accuracy of the calculated percentage error.

Using the factory set **LOG CAL** of 6.25 Hz/kt:

- If the display is under reading by 10% subtract 0.62
- If the display is over reading by 10% add 0.62

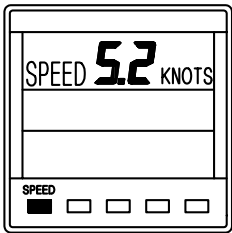

Press **SPEED** key to display current boat speed.

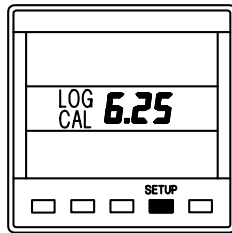

Press **SETUP** key four times to display **LOG CAL**.

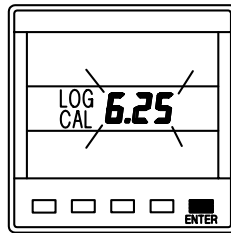

Press **ENTER** key to adjust the displayed value.

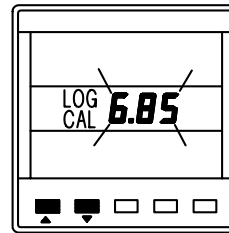

Use ▲ or ▼ to change the value.

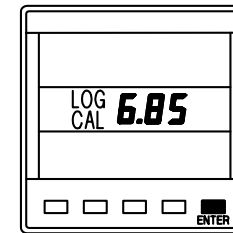

Press **ENTER** to store the new value in memory.

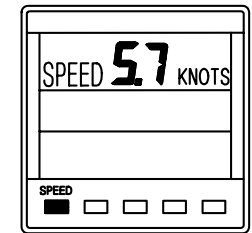

Press **SPEED** key to complete change.

METHOD 3. - AUTOMATIC CALIBRATION - AUTO CAL

This procedure will automatically and accurately calibrate the boat speed and log and is the recommended method for most boats.

NOTE: AUTO CAL can be aborted any time by pressing the **SETUP** key, then the **SPEED** key.

- Select two markers that are easily identifiable on the ground and on a chart, choose a place where the current is at a minimum. Measure and record the distance between the markers on the chart.
- It is recommended that three runs are carried out, this accounts for tidal efforts, and improves accuracy. However a time should be selected when the current is at a minimum, ie slack water between tides.

IMPORTANT NOTE: The total distance accumulated over the three runs must exceed 0.16 Nautical Miles or 100 metres per run. If this is not achieved the **AUTO CAL** will fail and the procedure will have to be repeated.

- Press the **SPEED** key to select current boat speed.
- Press the **SETUP** key five times to display **AUTO CAL**.

- Press the **ENTER** key when in line with marker A, to start run 1. The display will flash **AUTO CAL 1**. Press **ENTER** key again when in line with marker B, to freeze run 1. The display will flash, showing the distance so far for one run.
- Turn the boat around for run 2 in the opposite direction over the same measured distance. Press the **ENTER** key when in line with marker B, to start run 2. The display will flash **AUTO CAL 2**. Press **ENTER** key again when in line with marker A, to freeze run 2. The display will flash the accumulated distance so far for two runs.
- Turn the boat around for run 3 (final run) in the opposite direction over the same measured distance. Press the **ENTER** key when in line with marker A, to start run 3. The display will flash **AUTO CAL 3**. Press **ENTER** key again when in line with marker B, to freeze run 3. The display will flash the accumulated distance for three runs.
- Multiply the recorded distance from the chart by the number of runs completed. This is the true distance travelled.
- Adjust the flashing display with the ▲ or ▼ keys until it is the same as the true distance.
- Press the **ENTER** key to complete the calibration. The display will zero, and the calibration is memorised.

AUTOMATIC CALIBRATION PROCEDURE

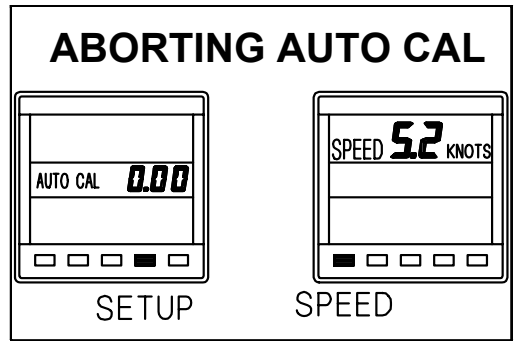
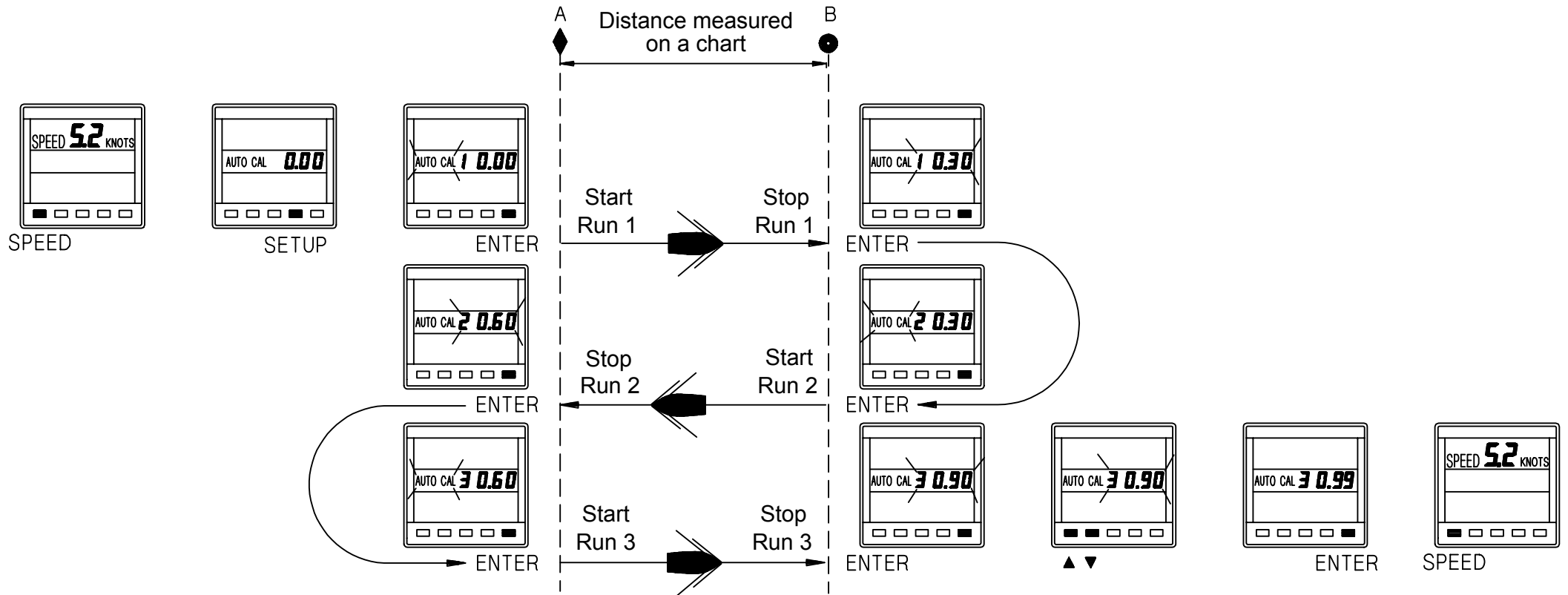

RESETTING THE DEAD RECKONED DISTANCE

This facility allows the Dead Reckoned (DR) distance log to be reset. The Network QUAD unit cannot display the DR information, however Network SPEED and Network DATA both display it.

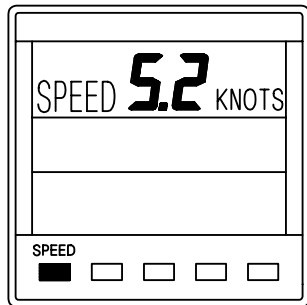

Press **SPEED** key to display the current boat speed.

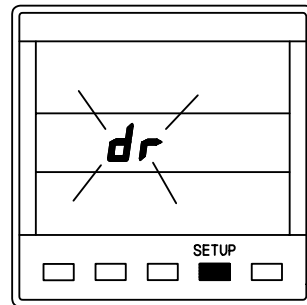

Press **SETUP** key 6 times to display **dr**. The display will flash.

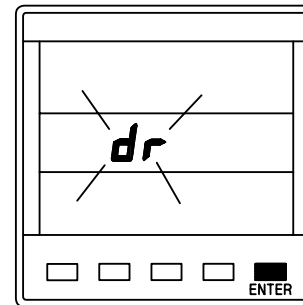

Press **ENTER** key, there will be no change on the QUAD unit LCD but the **dr** log has been reset.

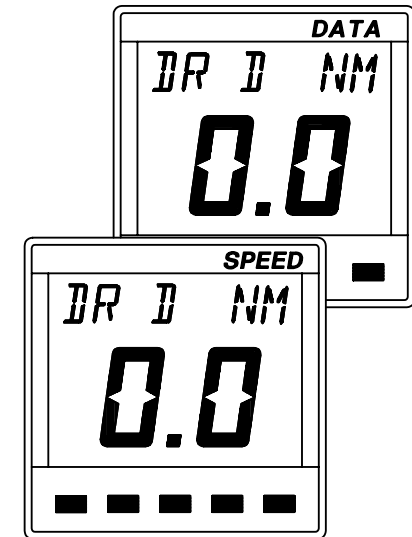

The **dr** log will be reset to zero when displayed on SPEED or DATA units.

USING THE DEPTH KEY

The current water depth is permanently displayed in the bottom LCD area in metres, feet or fathoms. The unit is factory set to metres. The depth displayed is from the depth datum, see DEPTH DATUM. Press the DEPTH key to cycle through the following options:

CAL The Depth Datum can be adjusted so the displayed water depth is from the water-line, the depth sensor (transducer) or the keel or outdrive depth. The unit is factory set to display water depth from the transducer.

SHALLOW ALARM When enabled it will sound if the water depth is less than the alarm value.

DEEP ALARM When enabled it will sound if the water depth is more than the alarm value.

ANCHOR ALARM When enabled it will sound if the water depth is outside two alarm limits.

The Network QUAD unit can measure and display water depth in the following ranges:

- 0.7 to 180 metres
- 2'4" to 590'
- 0.37 to 98.4 fathoms

Accuracy $\pm 2\%$ or $\pm 0.2\text{m.}(\pm 8\text{'})$

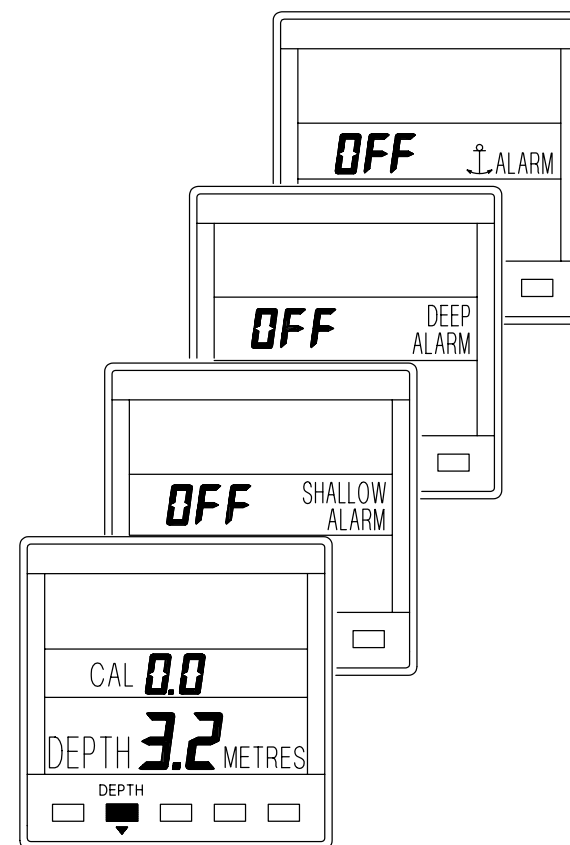

THE DEPTH DATUM - CAL

The depth datum **CAL** is an offset calibration value used to determine the displayed information reference point. It is added to the actual measured water depth to display the depth from the waterline, the depth sensor (transducer) or the keel/outdrive depth.

The Network QUAD unit has factory set **CAL** of zero, i.e. the depth is displayed from the transducer. The **CAL** value is displayed in the same units as the depth.

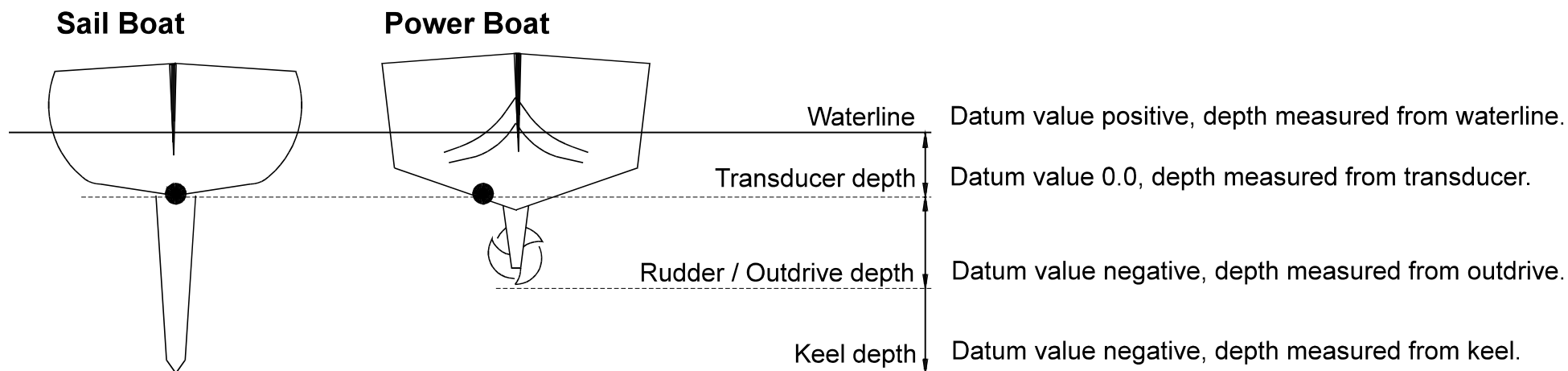

SETTING THE DEPTH DATUM

CAL zero, depth from transducer.

CAL positive, depth from waterline.

CAL negative, depth from keel.

NOTE: If the CAL LOCK is set then the CAL value cannot be changed. Consult your B&G dealer for further advice.

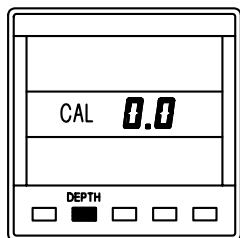

Press **DEPTH** key to display depth datum **CAL**.

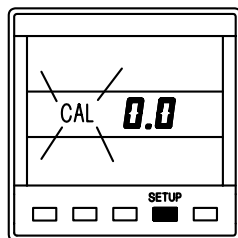

Press **SETUP** key to display current datum value. The display will flash.

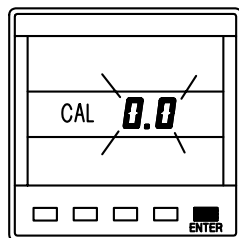

Press **ENTER** to adjust the datum value. The value will flash.

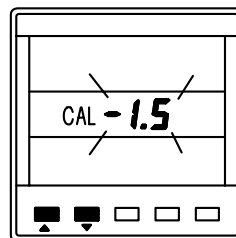

Use ▲ or ▼ to adjust the value.

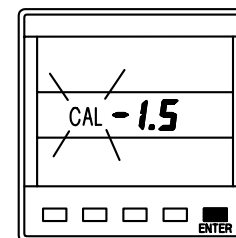

Press **ENTER** to memorise the new value.

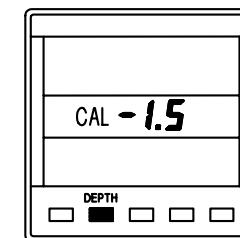

Press **DEPTH** to display the depth datum.

SETTING THE DEPTH UNITS

The Network QUAD unit can be set to display depth in Metres, Feet or Fathoms. The selected units are used for displayed depth information on all Network instruments on the entire Network system.

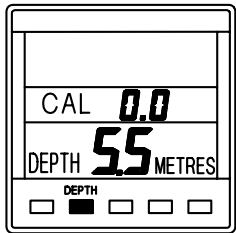

Press **DEPTH** key to display the current depth.

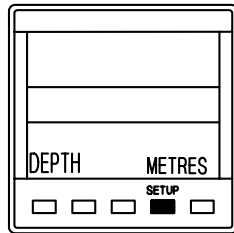

Press **SETUP** key twice. The depth display will go blank.

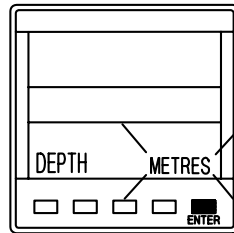

Press **ENTER** key if the units are to be changed.

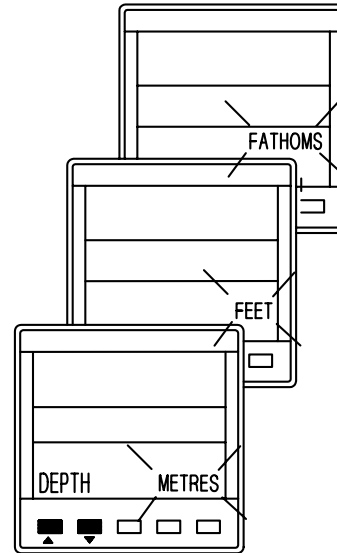

Use **▲** or **▼** to change the units.

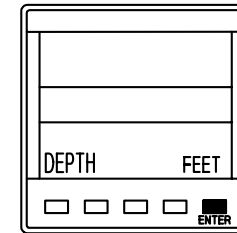

Press **ENTER** key to memorise the change.

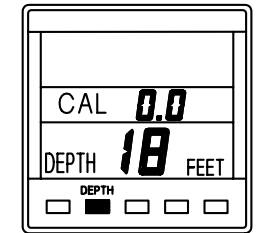

Press **DEPTH** to display current depth.

DEPTH ALARMS

The display will show **OFF** if the alarm is disabled or the alarm value when enabled. The value will be displayed in metres, feet or fathoms depending on the selected depth units.

When the alarm condition is met the unit will sound its' internal alarm buzzer and flash **DEPTH METRES**. Silence the alarm by pressing any key. The alarm information is broadcast to all other Network units via the system network cables, these will also sound their alarms and flash their displays, except Network WIND and Network TACK which do not have alarms. See NETWORK ALARMS at the end of this manual.

Shallow Alarm

- Factory set to 1.0m, (3.2ft, 0.5 fathoms).
- Adjustable range 0 - 180m, 0 - 590ft, 0 - 98.4 fa.

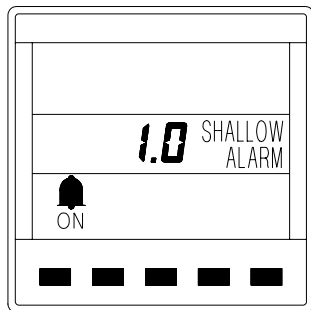

Deep Alarm

- Factory set to 10.0m, (32.8ft, 5.4 fathoms).
- Adjustable range 0 - 180m, 0 - 590 ft, 0 - 98.4 fa.

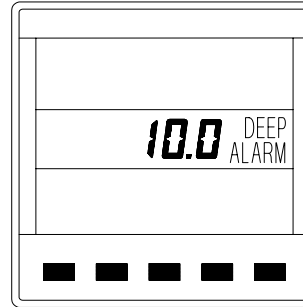

Anchor Alarm

- Factory set Shallow 0.5m Deep 1.0m,
- (1.6/3.2ft, 0.2/.5 fathoms).
- Adjustable range 0 - 180m, 0 - 590 ft, 0 - 98.4 fa.

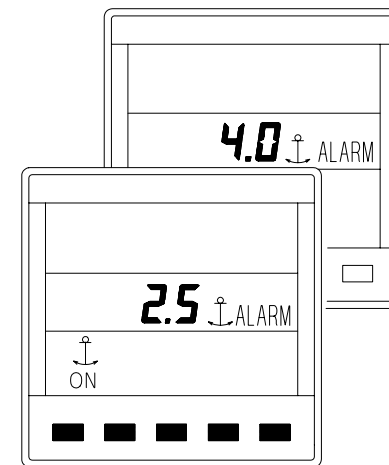

ENABLING/DISABLING THE SHALLOW ALARM

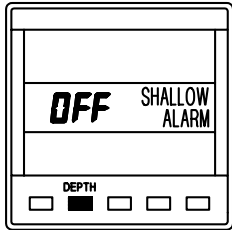

Press **DEPTH** key to display the shallow alarm.

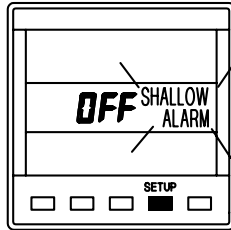

Press **SETUP** key, the alarm state will be displayed.

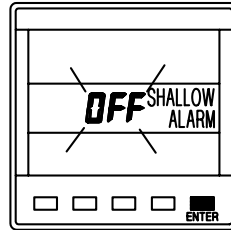

Press **ENTER** key, the alarm state display will flash.

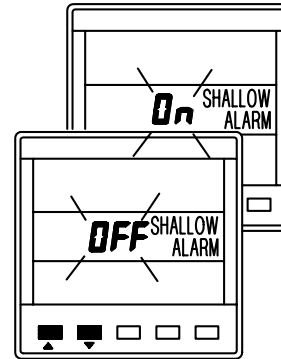

Use **▲** or **▼** to enable/disable the alarm.

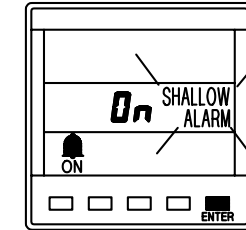

Press **ENTER** to memorise the change.

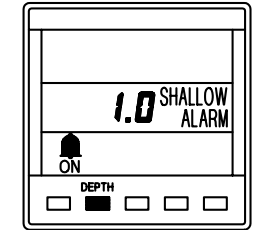

Press **DEPTH** key, the current value is displayed.

ADJUSTING THE SHALLOW ALARM VALUE

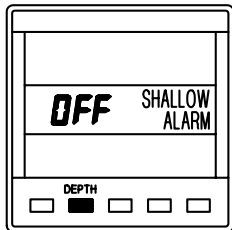

Press **DEPTH** key to display the shallow alarm.

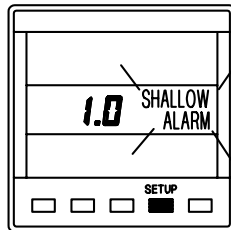

Press **SETUP** key twice, the value is displayed.

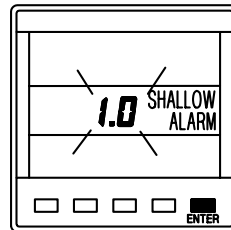

Press **ENTER** key, the value display will flash.

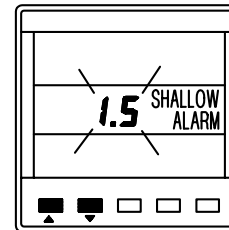

Use **▲** or **▼** to adjust the value.

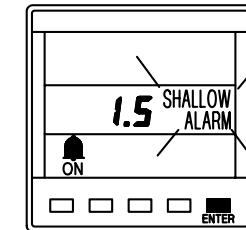

Press **ENTER** key to memorise the new value.

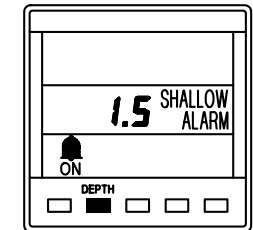

Press **DEPTH** key, the value is displayed and the alarm enabled.

ENABLING/DISABLING THE DEEP ALARM

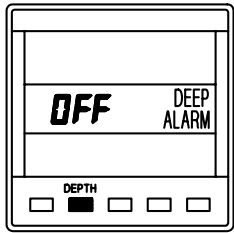

Press **DEPTH** key to display the deep alarm.

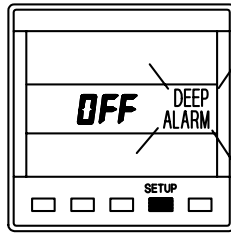

Press **SETUP** key, the alarm state will be displayed.

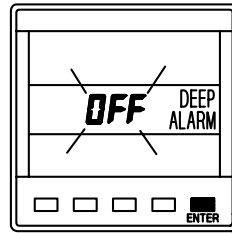

Press **ENTER** key, the alarm state display will flash.

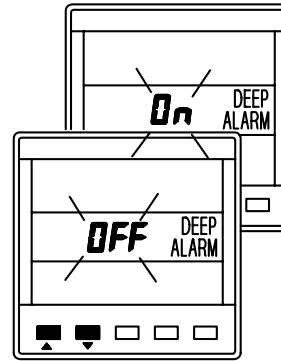

Use ▲ or ▼ to enable/disable the alarm.

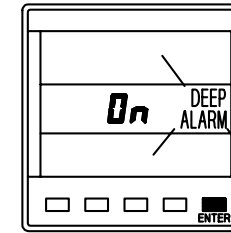

Press **ENTER** to memorise the change.

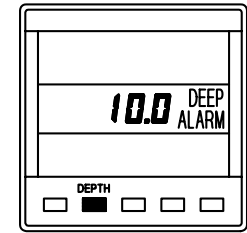

Press **DEPTH** key, the current value is displayed.

ADJUSTING THE DEEP ALARM VALUE

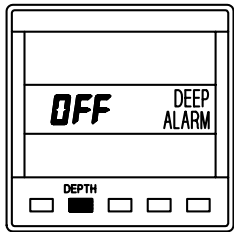

Press **DEPTH** key to display the deep alarm.

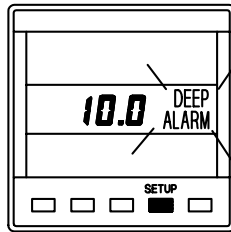

Press **SETUP** key twice, the value is displayed.

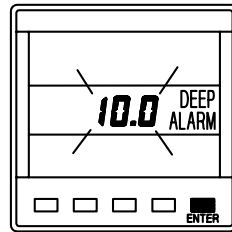

Press **ENTER** key, the value display will flash.

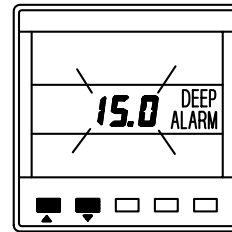

Use ▲ or ▼ to adjust the value.

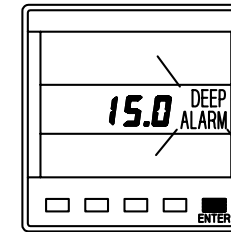

Press **ENTER** key to memorise the new value.

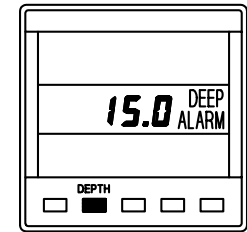

Press **DEPTH** key, the value is displayed and the alarm enabled.

USING THE ANCHOR ALARM

The Anchor Alarm uses two adjustable alarm limits. The alarm will sound if the water is deeper or shallower, by the set values, than the original depth of water when the alarm was enabled. This allows you to adjust your anchor chain according to the tides.

The Network QUAD unit has a factory set Shallow limit of 0.5m and Deep limit of 1.0m.

In the following example, the original water depth was 3m when the alarm was enabled. Using the factory set values, the water depth could increase to 4m ($3\text{m} + 1\text{m}$) and decrease to 2.5m ($3\text{m} - 0.5\text{m}$) before the alarm would sound.

The anchor alarm depth limits are shown alternatively when they are enabled and displayed using the **DEPTH** key.

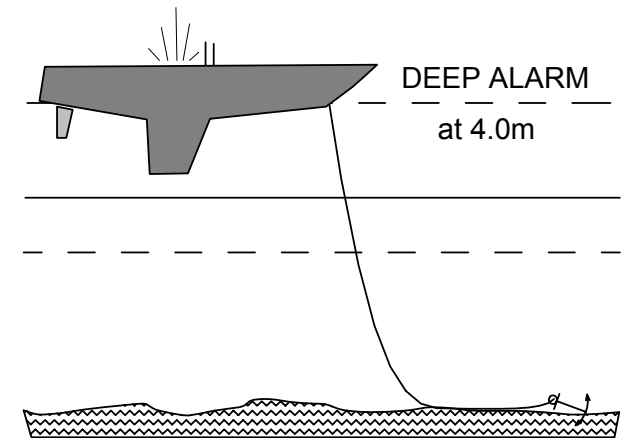
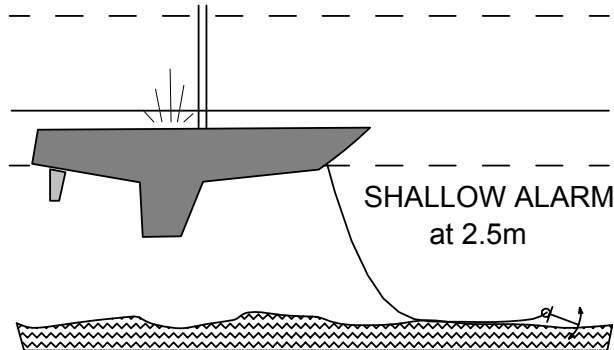
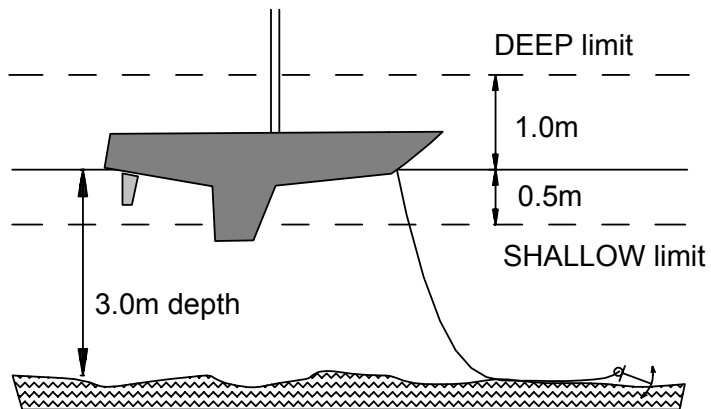
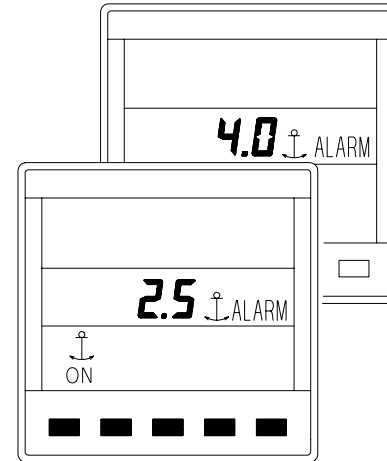

ENABLING/DISABLING THE ANCHOR ALARM

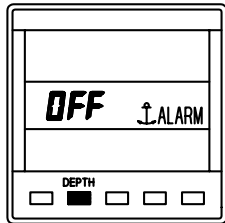

Press **DEPTH** key to display **ANCHOR ALARM**

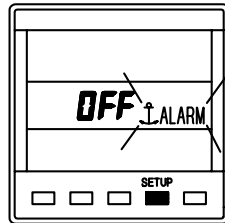

Press **SETUP** key, to display alarm state.

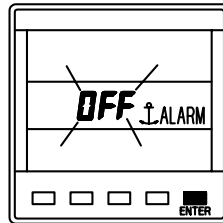

Press **ENTER** key, the alarm state display will flash.

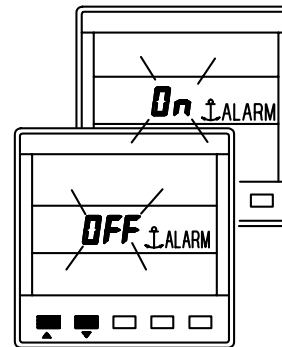

Use ▲ or ▼ to enable or disable the alarm.

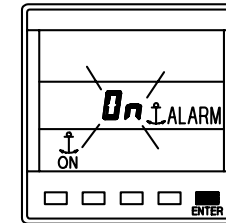

Press **ENTER** to memorise the new alarm state.

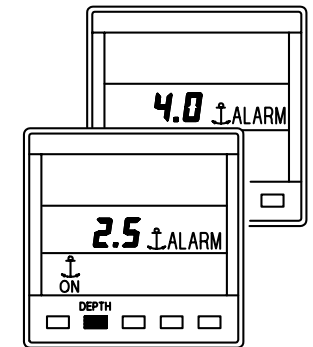

Press **DEPTH** key to display the anchor alarm.

ADJUSTING THE ANCHOR ALARM SHALLOW LIMIT

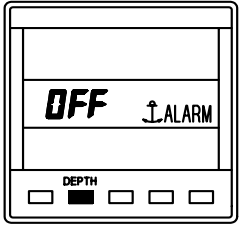

Press **DEPTH** key to display anchor alarm.

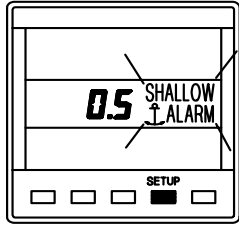

Press **SETUP** key twice to display the shallow value.

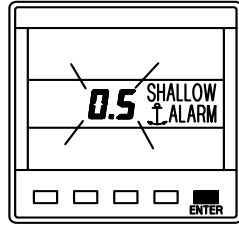

Press **ENTER** key, the value display will flash.

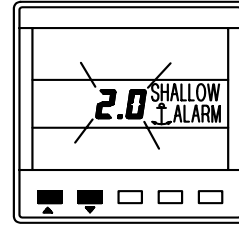

Use ▲ or ▼ to change the value.

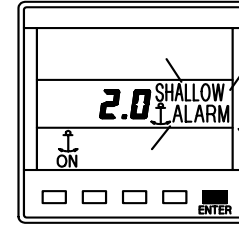

Press **ENTER** to memorise the new value and enable the alarm.

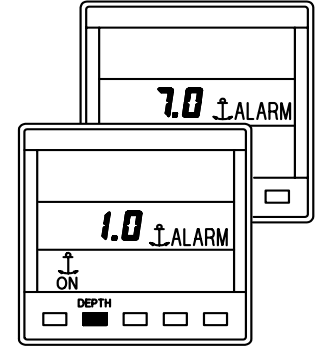

Press **DEPTH** key to display the anchor alarm.

ADJUSTING THE ANCHOR ALARM DEEP LIMIT

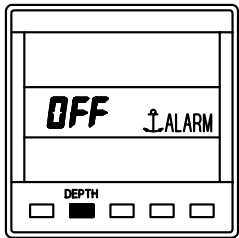

Press **DEPTH** key to display anchor alarm.

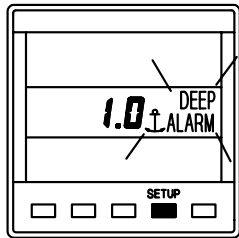

Press **SETUP** key 3 times to display the deep value.

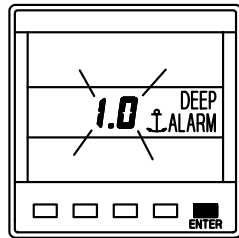

Press **ENTER** key, the value display will flash.

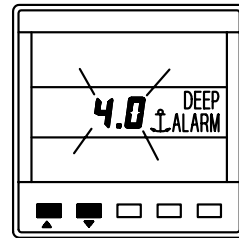

Use ▲ or ▼ to change the value.

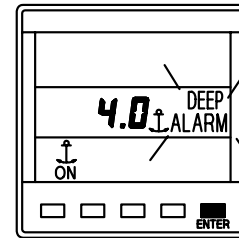

Press **ENTER** to memorise the new value and enable the alarm.

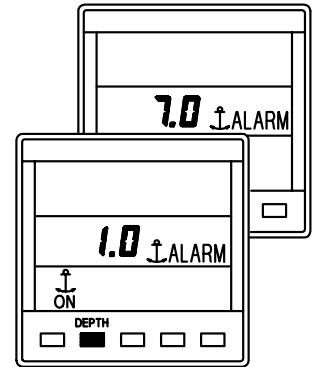

Press **DEPTH** key to display the anchor alarm.

USING THE TIMER/TEMP KEY

Press the **TIMER/TEMP** key to cycle through the options:

TRIP LOG A reset log that can be displayed in Nautical miles or Statute Miles. This is determined by the selection of the displayed speed units (see **SETTING THE SPEED AND LOG UNITS**). It also resets the Maximum and Average Speed values.

LOG The Stored Log, in **NM** or **M** as above.

TIMER There are three timers available:

1. 10 minute count-down
2. 5 minute count-down
3. Count-up starting from zero.

- The 10 minute count-down timer sounds a bleep at 5 and 1 minute, and then at 30, 20, 10, 5, 4, 3, 2, 1 seconds.
- The 5 minute count-down timer sounds a bleep at 1 minute, and then at 30, 20, 10, 5, 4, 3, 2, 1 seconds.
- All the timers count in one second intervals up to 99 hours, 59 minutes and 59 seconds.
- When a count-down timer reaches zero it will begin to count up.
- All timers have a Lap Time facility that will freeze the displayed time while the timer remains counting.

SEA TEMPERATURE

The Sea Temperature is displayed in °C Celsius or °F Fahrenheit.

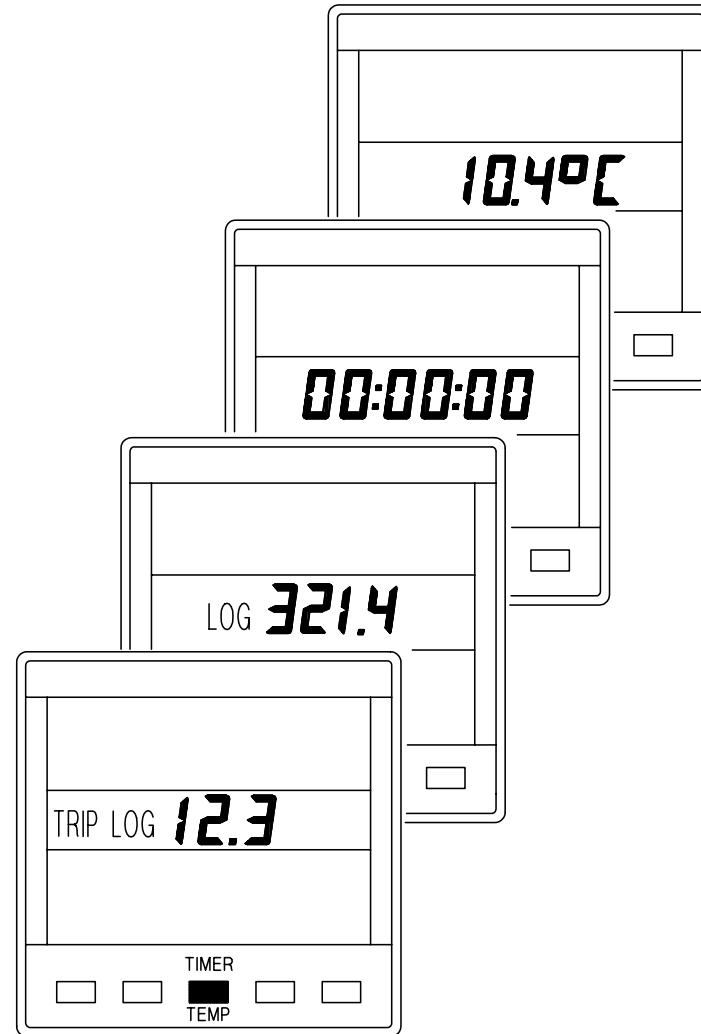

RESETTING THE TRIP LOG

The Trip Log is reset to zero and starts again as soon as the **ENTER** key is pressed.

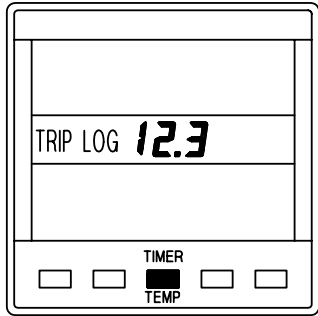

Press **TIMER** key to display the **TRIP LOG**.

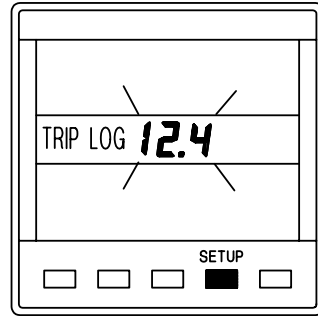

Press **SETUP** key, Display flashes.

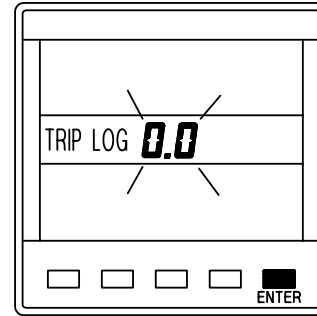

Press **ENTER** key, the display resets to zero, and remains flashing.

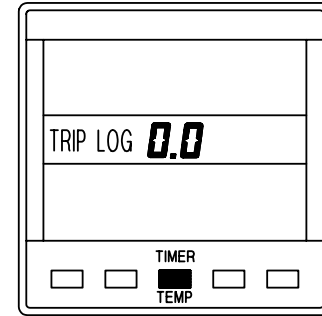

Press **TIMER** key to display the **TRIP LOG**.

SETTING THE TIMERS AND LAP TIMER

The Lap Timer can be used to 'freeze' the displayed time with any of the three Timers.

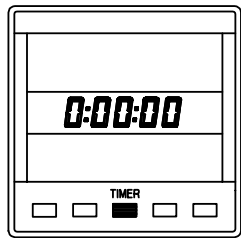

Press the **TIMER** key to display the timers.

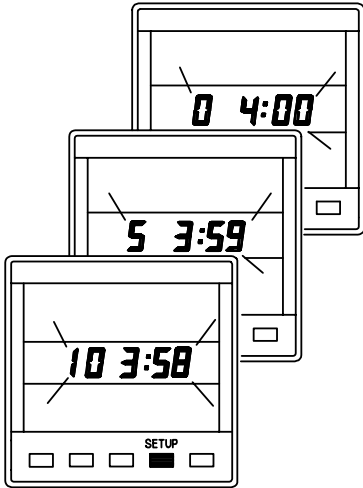

Press **SETUP** key
1 10 min.
2 5 min.
3 Count-up
The display will flash.

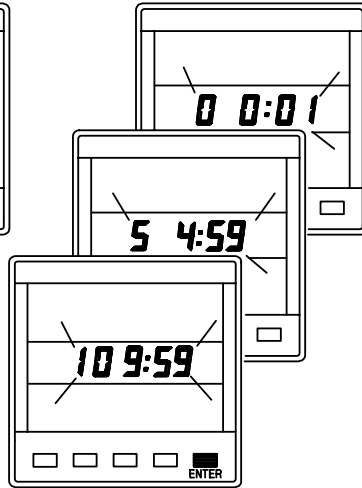

Press **ENTER** key, the display is set to the selected starting value. The timer starts to count.

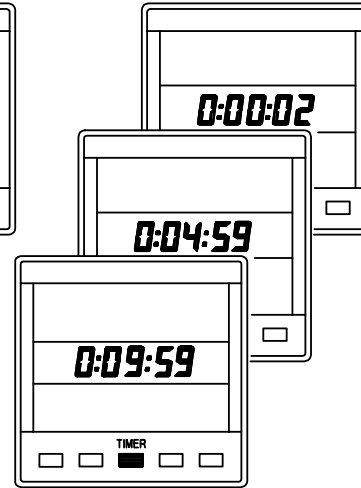

Press **TIMER** key, the display stops flashing and the timer is running.

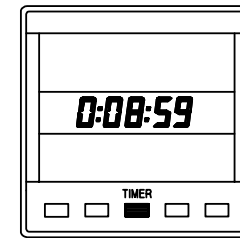

Press **TIMER** key to freeze the displayed time. The timer is still counting but not displayed

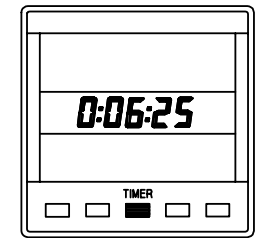

Press **TIMER** key 4 times to display the timer again.

SETTING THE TEMPERATURE UNITS

The sea temperature can be displayed in Celsius or Fahrenheit.

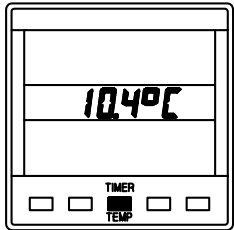

Press **TEMP** key until the sea temperature is displayed.

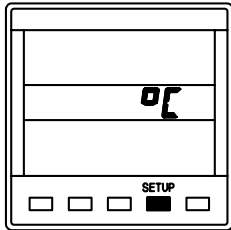

Press **SETUP** key once to display the current units.

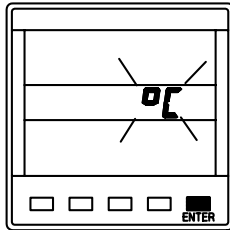

Press **ENTER** if the units are to be changed. The display will flash.

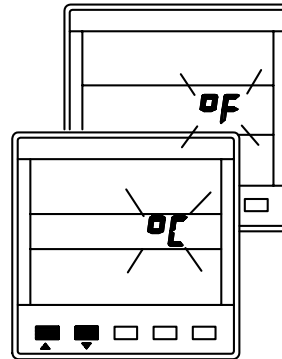

Use **▲** or **▼** keys to change the displayed units.

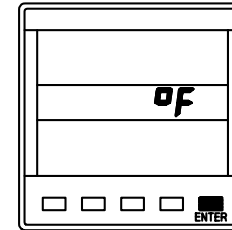

Press **ENTER** key to memorise the new units.

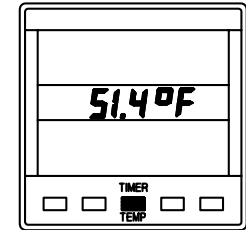

Press **TEMP** key to display sea temperature.

CALIBRATING THE TEMPERATURE SENSOR

Temperature calibration should only be carried out when the built-in sea water temperature sensor (part of the speed sensor) is considered to be inaccurate. The temperature of the water will have to be measured with an accurate temperature sensing device, this value can then be entered into the Network QUAD unit.

In the following example the unit is displaying a reading of 10.4°C, the water temperature is known to be 11.4°C. The correct value is entered into the Network QUAD unit.

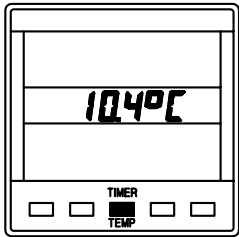

Press **TEMP** key until **TEMP °C** is displayed.

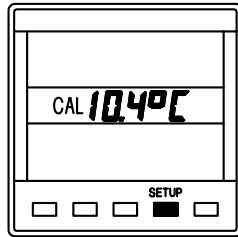

Press **SETUP** key twice to display **CAL °C**.

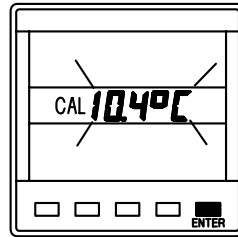

Press **ENTER** if required to change the displayed value. The display will flash.

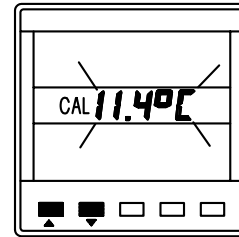

Use **▲** or **▼** keys to change the displayed value.

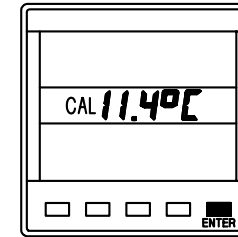

Press **ENTER** key to memorise the new value.

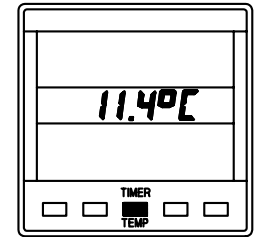

Press **TEMP** key to display sea temperature.

USING THE LIGHTS KEY

The Network QUAD Display unit has 3 levels of illumination and off, controlled by the **LIGHTS** key. It also changes the illumination level of the key legends.

The LIGHTS key is always illuminated so even in complete darkness the key can be located.

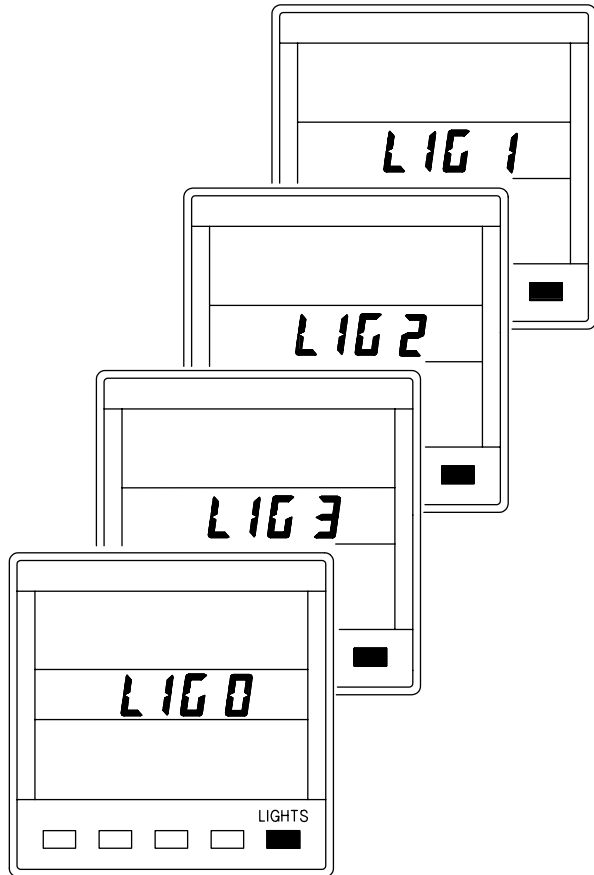

- **LIG 0** OFF
- **LIG 3** High
- **LIG 2** Medium
- **LIG 1** Low

NETWORK ALARMS

The Network QUAD unit has an internal buzzer that will sound when an alarm condition is met on a Network unit that has alarm functions ie. Network DEPTH and Network QUAD for depth alarms and Network PILOT for Watch Alarm and Off Course alarms. The unit will also display which alarm is activated.

To silence the internal alarm and return the display to normal operation press any of the five keys.

DEPTH ALARM DISPLAY (NOT QUAD UNIT)

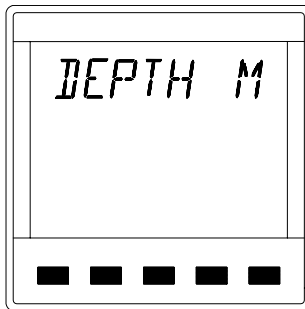

Depth alarms can be set for the following:

- Shallow water
- Deep water
- Anchor Watch

Check your Network DEPTH or QUAD unit to see which alarm is activated.

NETWORK PILOT ALARM DISPLAYS (NOT QUAD UNIT)

The Watch Alarm is a count-down timer with is activated at the end of the preset count-down period. The display alternates between the messages below.

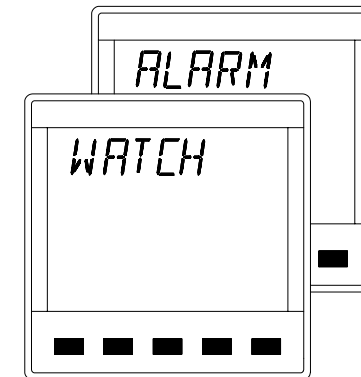

The Off Course alarm is activated when the boat deviates off course by a preset amount. The display alternates between the messages below:

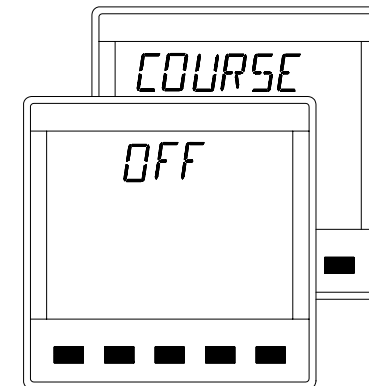

FAULT AND ERROR MESSAGES

NETWORK PILOT FAULT DISPLAY (NOT QUAD UNIT)

If the Network PILOT should have a fault the autopilot computer unit will send a message to all other Network Display Units. The Network units will alternately display the following message; the actual fault will have to read from the Network PILOT Display unit.

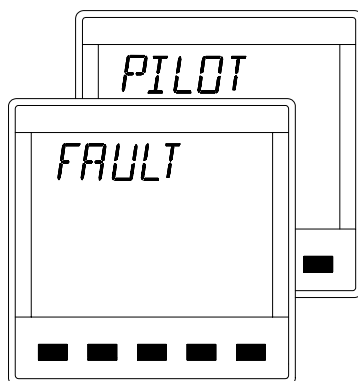

UNIT INTERNAL ERRORS

In the unlikely event that your Network QUAD unit should develop an internal error, the unit will sound its alarm continuously and the display will show an error number.

Press any of the keys to reset the error condition and silence this alarm. In some cases the fault can be cleared by switching off the instruments at the supply, waiting a few moments and then switching on again. If either of these methods does not clear the fault the error number should be recorded. Switch off the supply and disconnect the faulty unit. Return it with the error number to your dealer for servicing.

INSTALLATION

The display heads are supplied with a clip-in mounting bracket which allows for easy installation, access from behind is not necessary to secure the unit in place. However to prevent theft and permanently fix the unit in position, locking studs and thumb nuts are supplied.

SITING THE UNIT

All Network Instruments are designed for mounting on or below deck. A mounting position should be selected where they are:

- Easy to read by the helmsman
- On a smooth and flat surface
- At least 100mm (4") from a compass
- Accessible from behind for fitting locking studs if required

MOUNTING THE UNIT

Use the cutting template supplied to mark the centres of the holes for the self-tapping screw, the fixing stud holes and the mounting bracket.

- The template allows 4mm (5/32") between adjacent units for the suncover, increase this distance if required to maximum of 60mm (2 3/8") between units or 180mm (3 1/8") between centres. For greater distances between units extension cables are available.
- Use a 70mm (2 3/4") diameter hole-cutter for the mounting bracket hole.
- Use a 2.9mm for the self-tapping screw holes. Use a 5mm (3/32") drill for the locking stud holes.
- Secure the mounting bracket to the bulkhead with the self-tapping screws supplied
- Fit the rubber-sealing gasket around the mounting bracket.
- Screw the locking studs into the back of the display head (if required).
- Carefully pass the cable tails through the mounting bracket hole, connect the cables to the main units.
- Clip the display head into the mounting bracket.
- Secure the instrument with the thumb nuts supplied.

INSTALLATION DATA

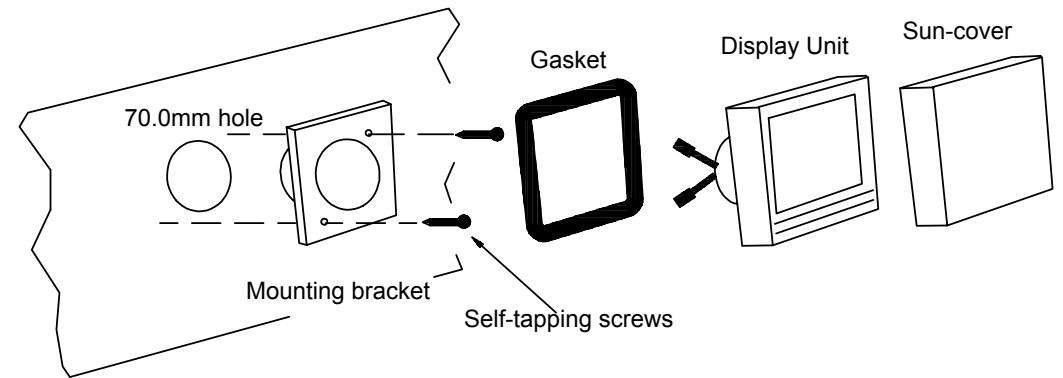
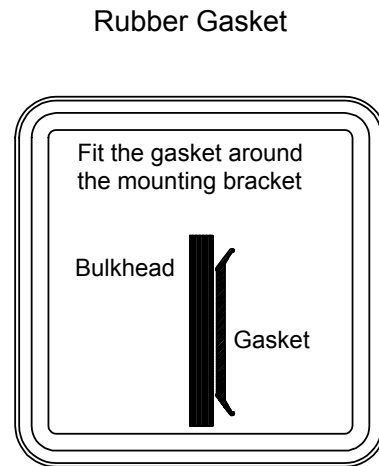
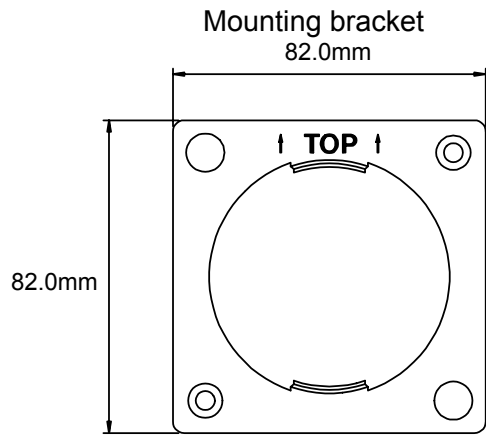
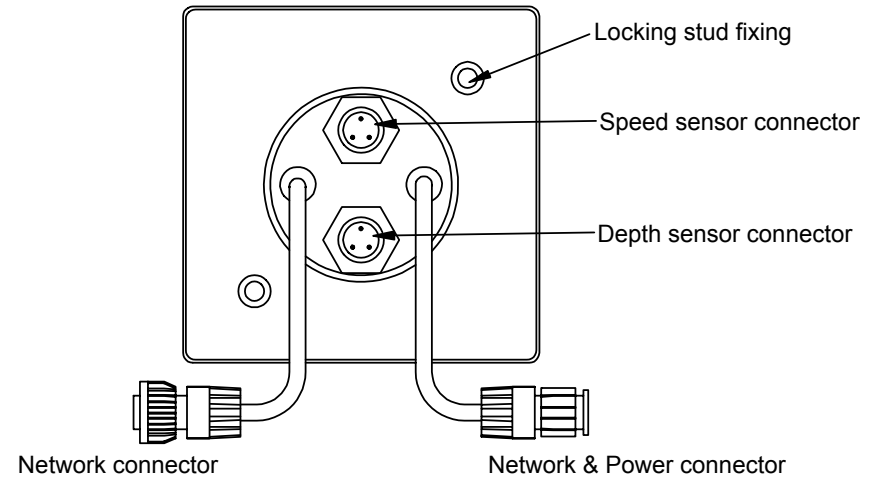
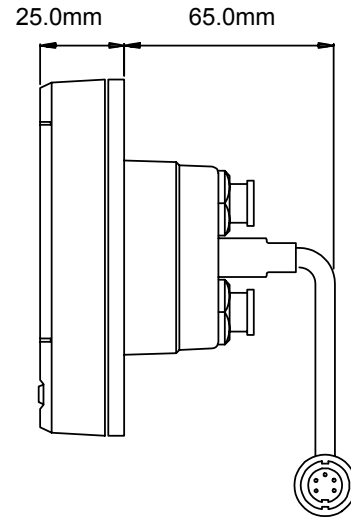
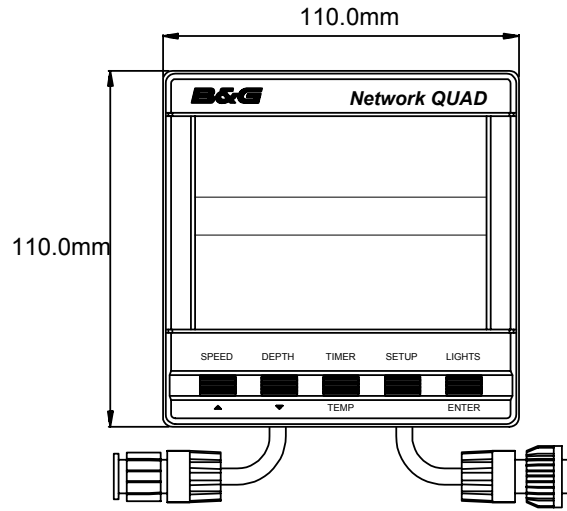

SPECIFICATION

PHYSICAL PARAMETERS

Construction	High impact ABS plastic
Window	Acrylic
Display	Back-lit Liquid Crystal Display: Large Digits: 15mm (0.6") Small Digits: 10mm (0.4")
Dimensions:	110 x 110 x 25.4mm (4 x 4 x 1") Requires 65mm (2.6") depth behind bulkhead for display barrel
Weight:	0.3 Kg (0.66lbs)

ENVIRONMENTAL

Operating Temp	-10 à+55°C, +14 to +131F @ 93%RH
Storage Temp	-25 à+70°C, -25 to +70C @ 95%RH
Humidity	Up to 95%RH
Sealing	Fully sealed front, suitable for bulkhead cockpit mounting. Vented barrel to prevent condensation.

ELECTRICAL

Power Supply	12V DC nominal (10 to 16V)
Operating Current	40mA typical, 100mA illuminated
Protection	Connect via external fuse or circuit breaker.

CABLES AND CONNECTIONS

Connection to adjacent units is via cable tails fitted with either a plug or a socket. Extension cables are available from your dealer. The cable tails carry power and NMEA data between units.

ALARM

Internal audible alarm. Control output for external alarm unit.

NMEA OUTPUT SENTENCES (QUAD REPEATER ONLY)

The Network QUAD does not have NMEA output.

\$IHD	Heading
\$IHDW	Speed and heading
\$IDBT	Depth
\$IIVWR	Apparent wind angle and wind speed
\$IIMTW	Sea temperature